

APPARENT RESISTIVITY PSEUDO SECTION

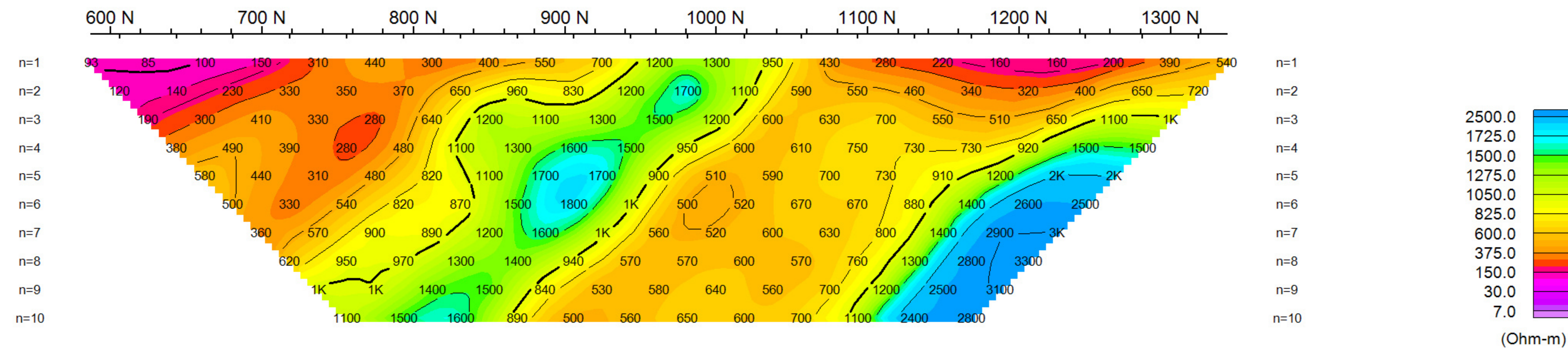

APPARENT CHARGEABILITY PSEUDO SECTION

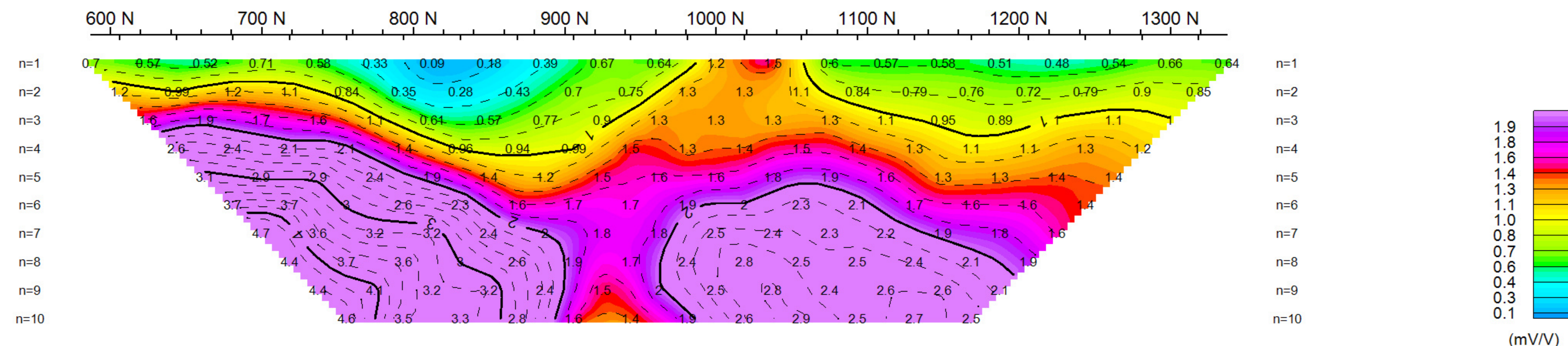

INTERPRETATION

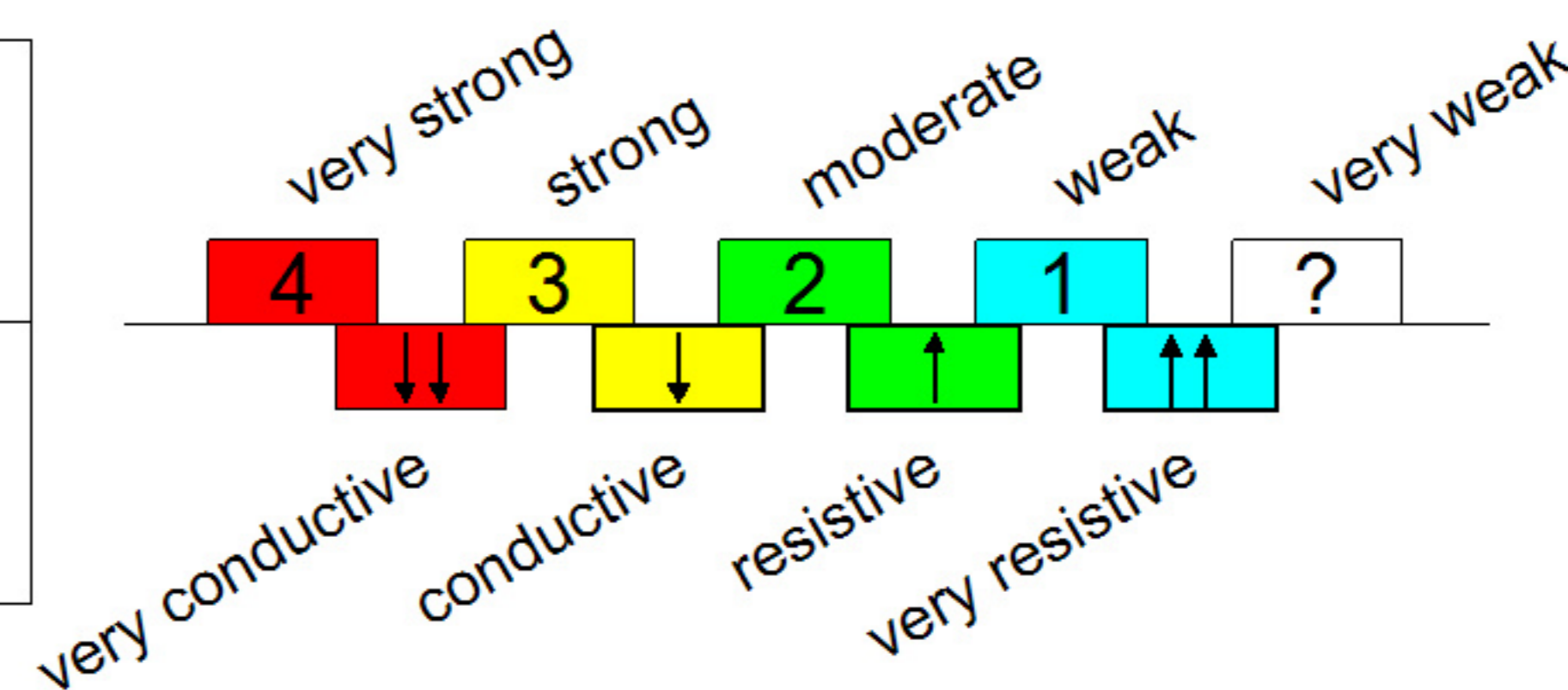
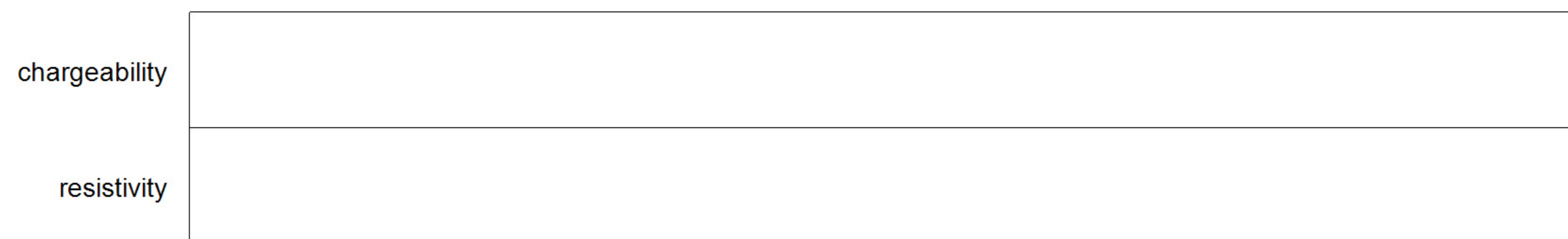

RESISTIVITY TRUE DEPTH SECTION

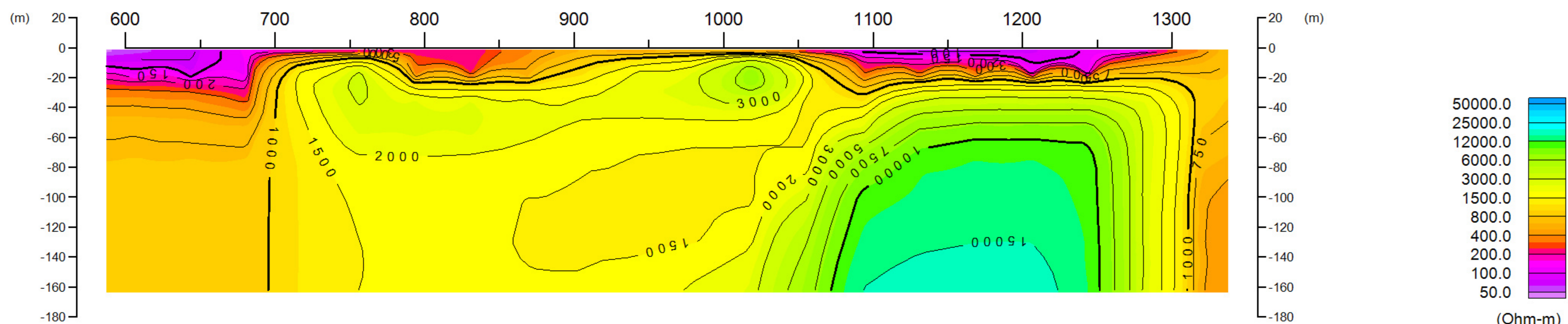

CHARGEABILITY TRUE DEPTH SECTION

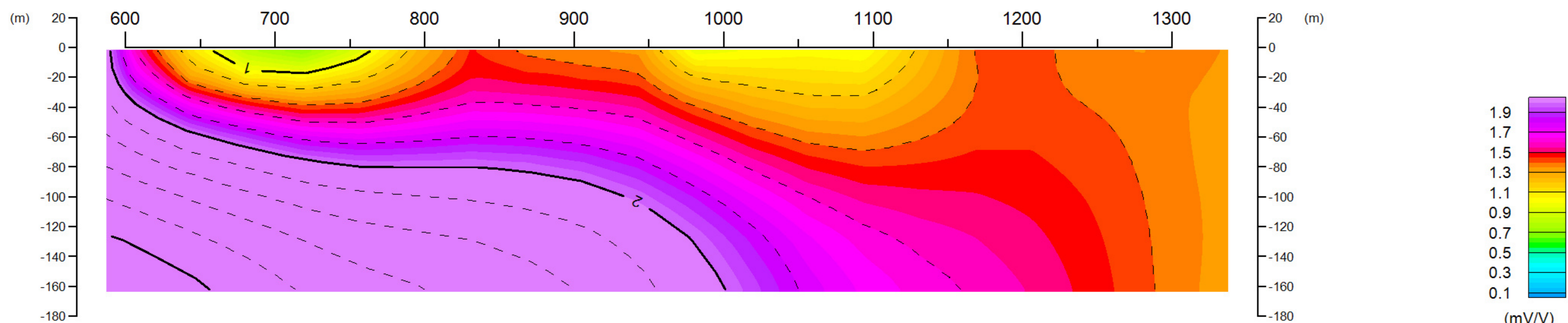

INDUCED POLARIZATION SURVEY

Pole-Dipole

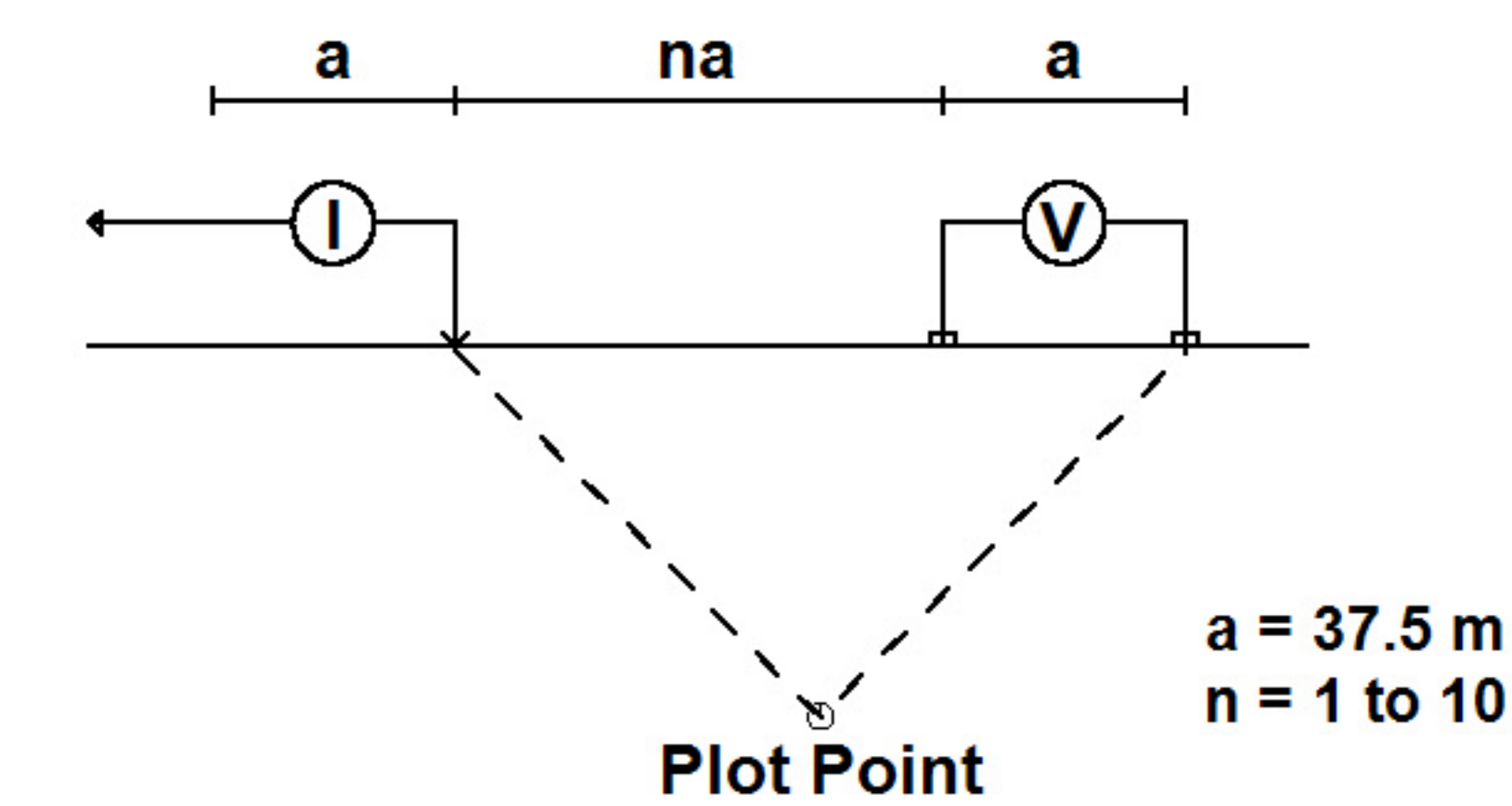

Transmitter: TXII, GDD Instrumentation

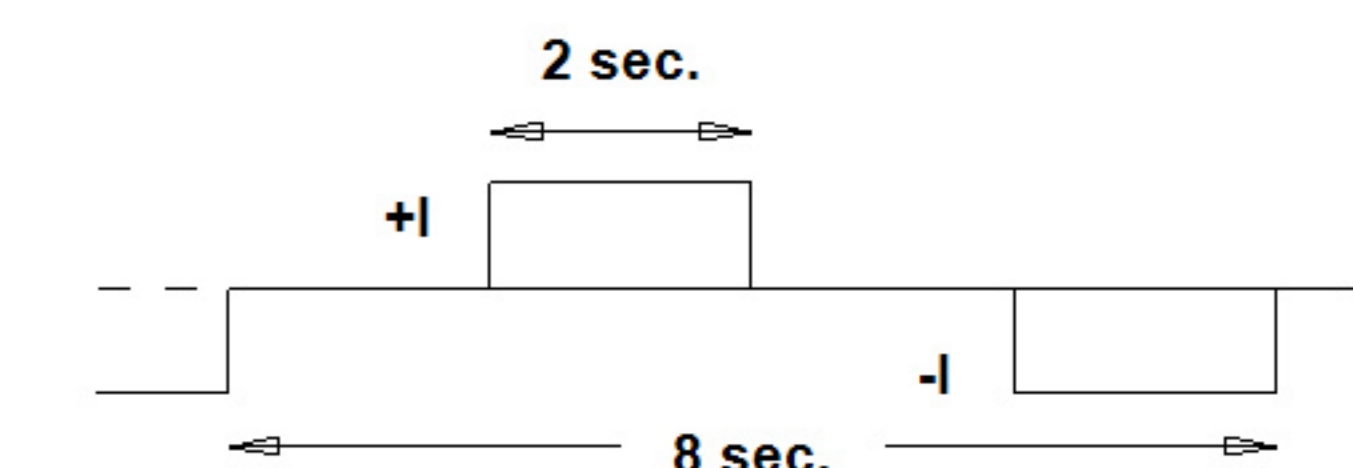

Receiver: Elrec Pro, Iris Instruments

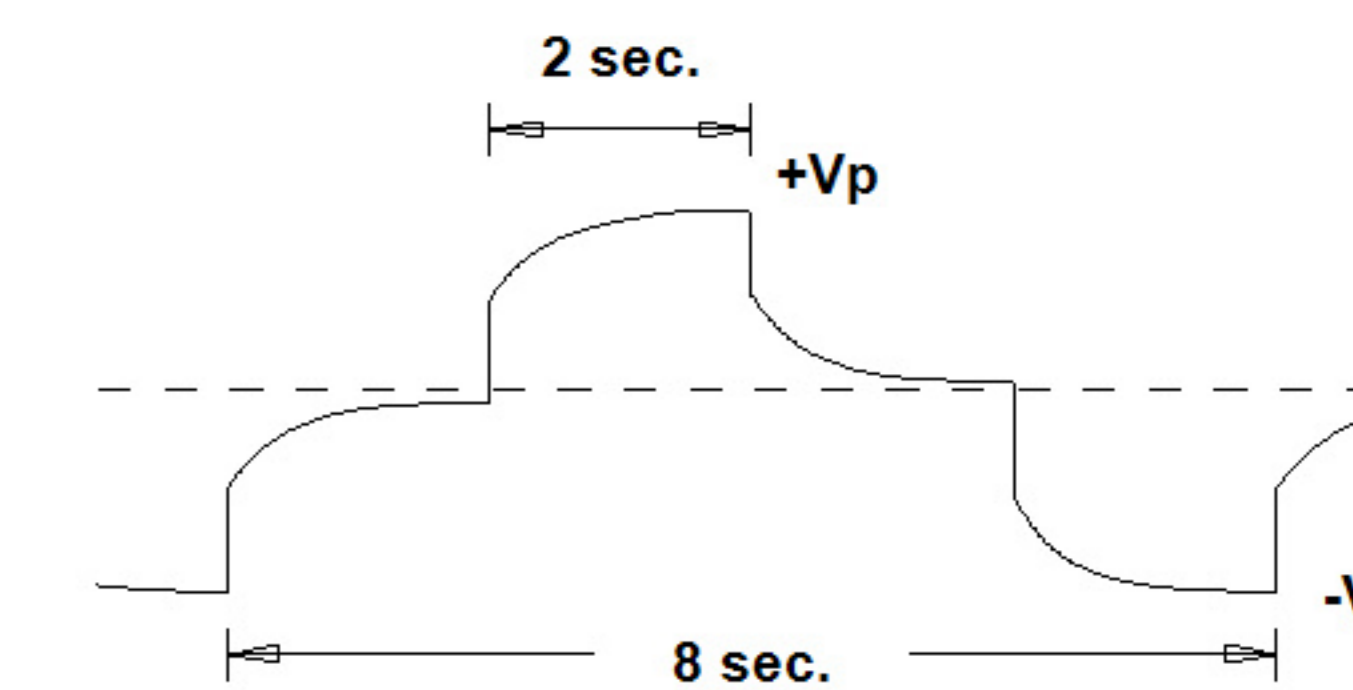

inversion **RES2DINV™**

Scale 1:5000

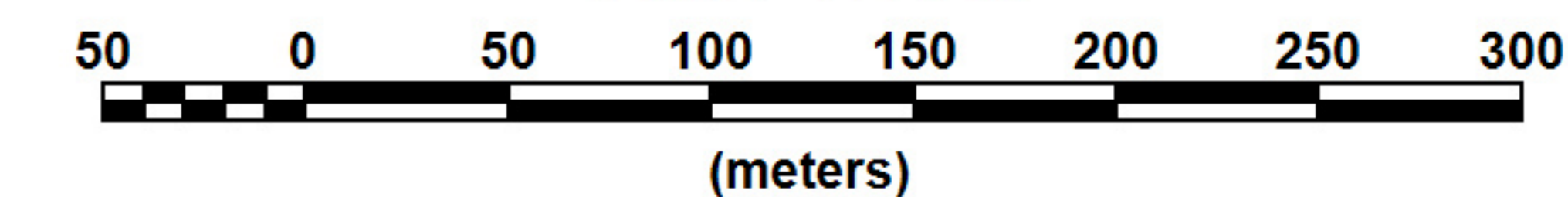

O3 MINING INC.

SISCOE PROJECT
VASSAN TOWNSHIP
VAL D'OR, QUEBEC

Line 0E

Interpreted by: Joël Simard, P.Geol./Geoph.
Verified by: Joël Simard, P.Geol./Geoph.
Surveyed by: J. Melançon
Date: January 2024
Ref: 24C672



APPARENT RESISTIVITY PSEUDO SECTION

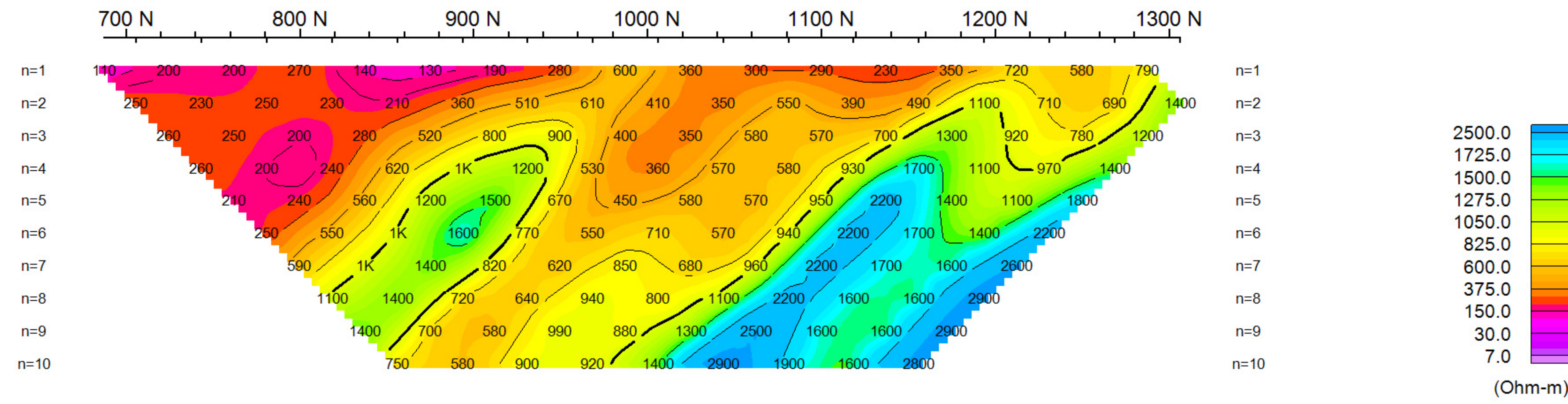

APPARENT CHARGEABILITY PSEUDO SECTION

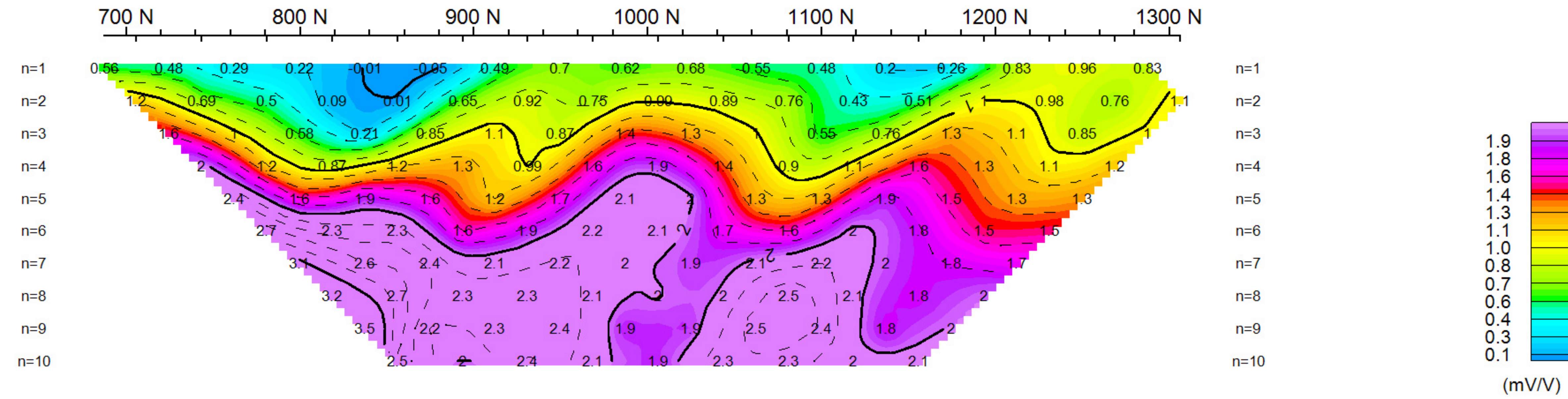

INTERPRETATION

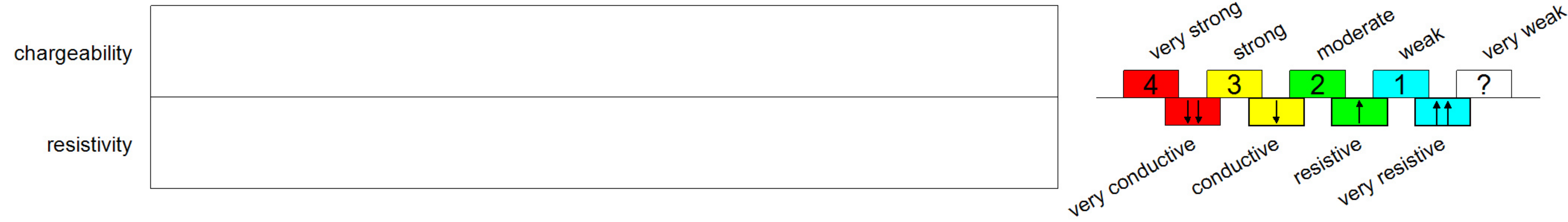

RESISTIVITY TRUE DEPTH SECTION

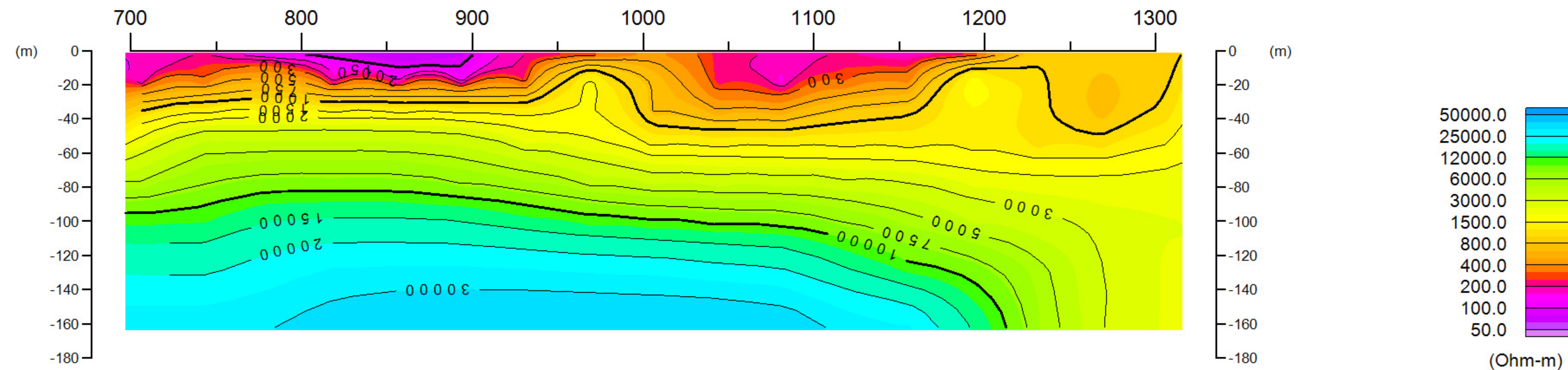

CHARGEABILITY TRUE DEPTH SECTION

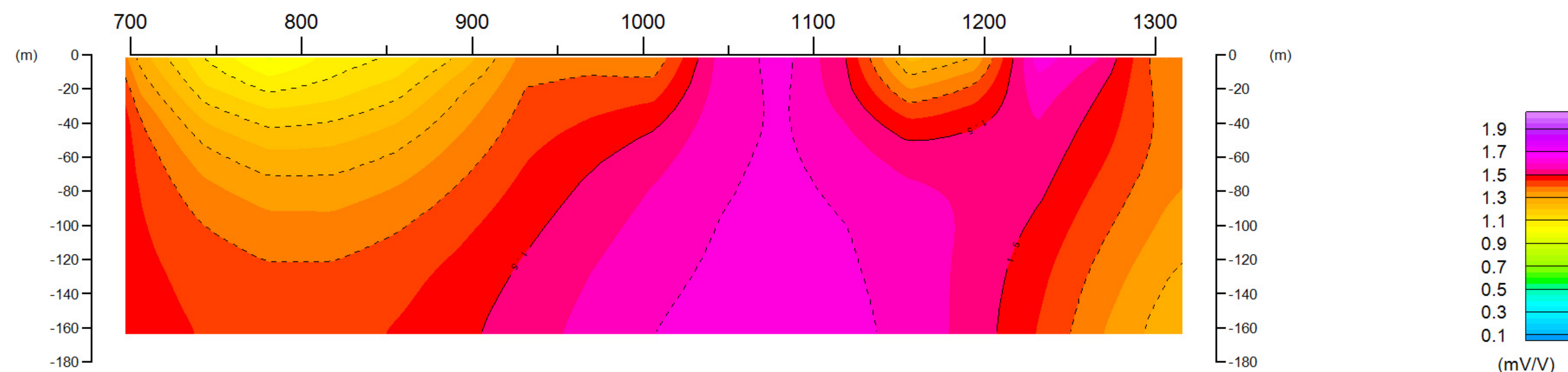

INDUCED POLARIZATION SURVEY

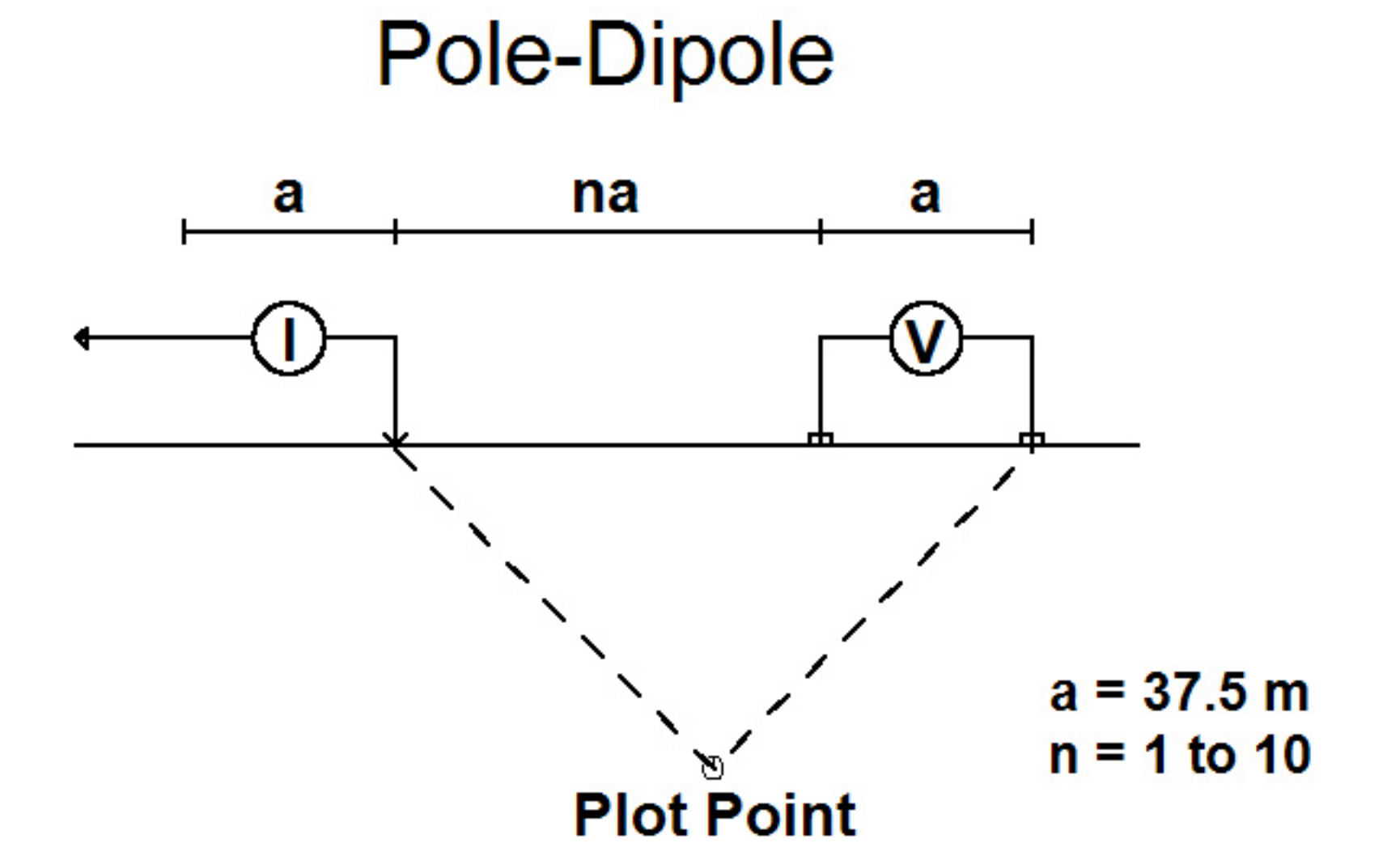

Transmitter: TXII, GDD Instrumentation

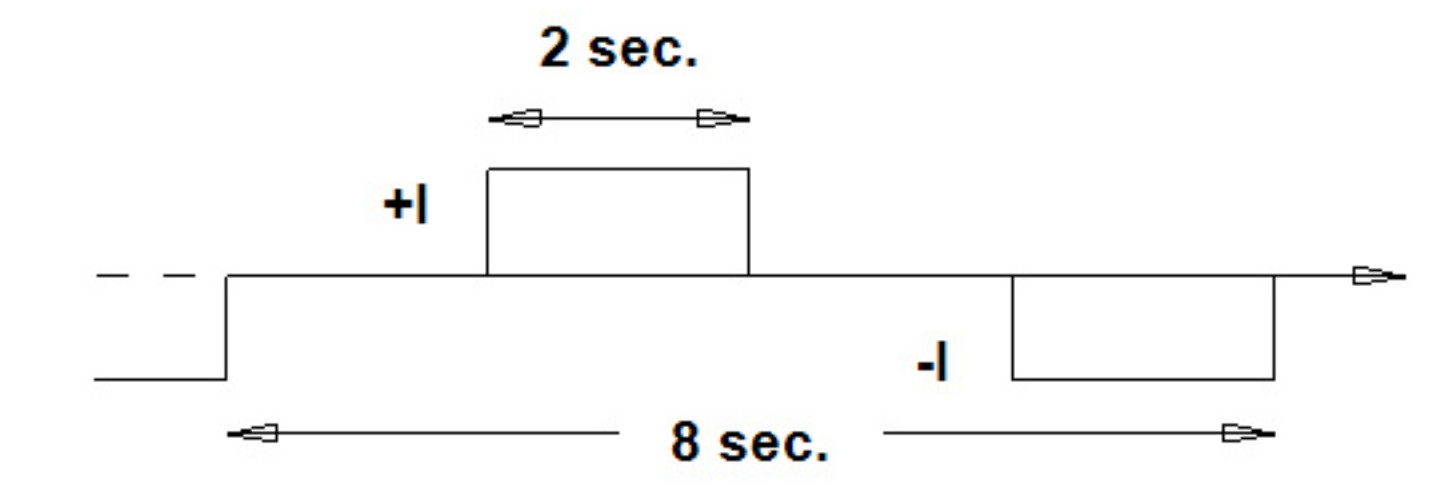

Receiver: Elrec Pro, Iris Instruments

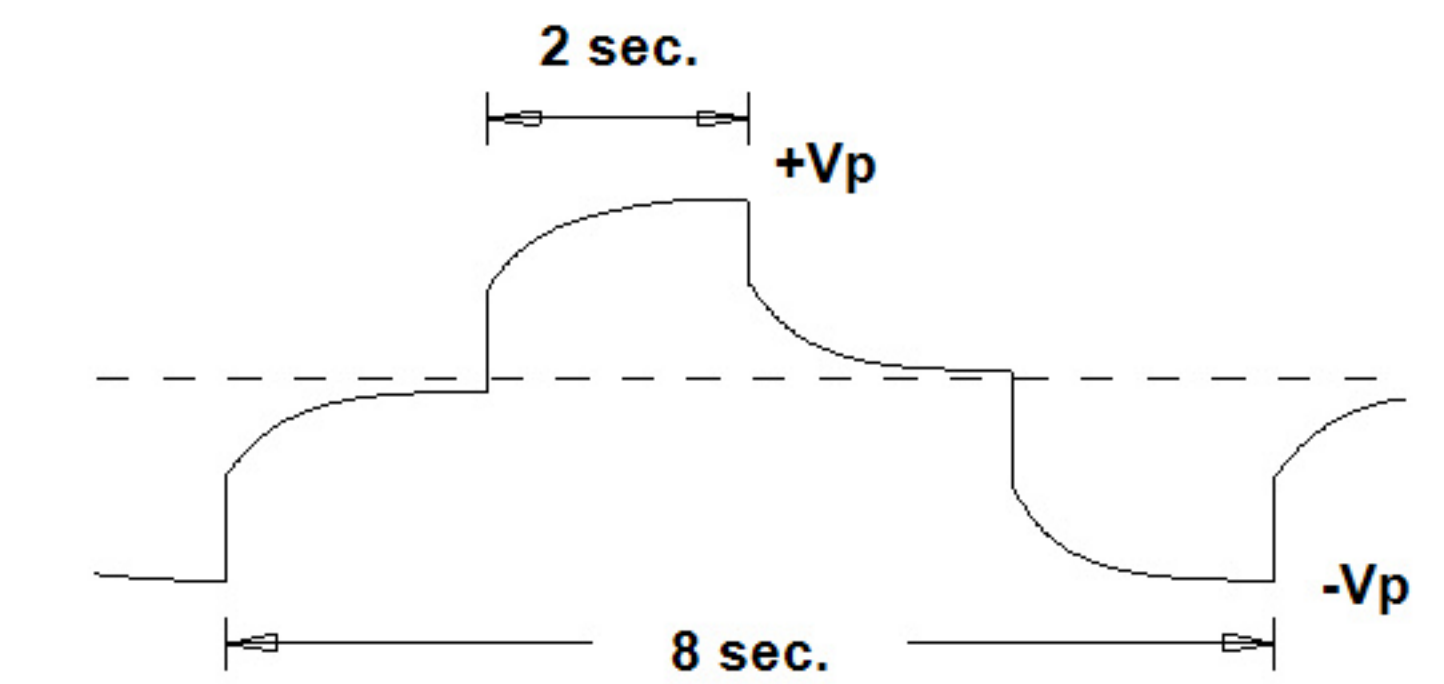

inversion **RES2DINV™**

Scale 1:5000

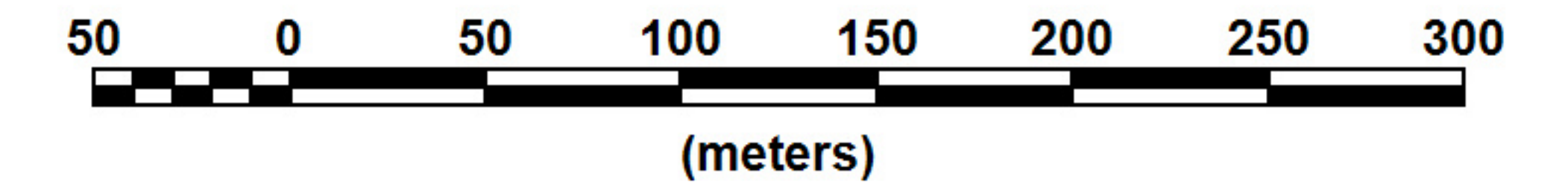

O3 MINING INC.

**SISCOE PROJECT
VASSAN TOWNSHIP
VAL D'OR, QUEBEC**

Line 400E

Interpreted by:
Verified by:
Surveyed by:
Date:
Ref:

Joël Simard, P.Geol./Geoph.
Joël Simard, P.Geol./Geoph.
J. Melançon
January 2024
24C672



APPARENT RESISTIVITY PSEUDO SECTION

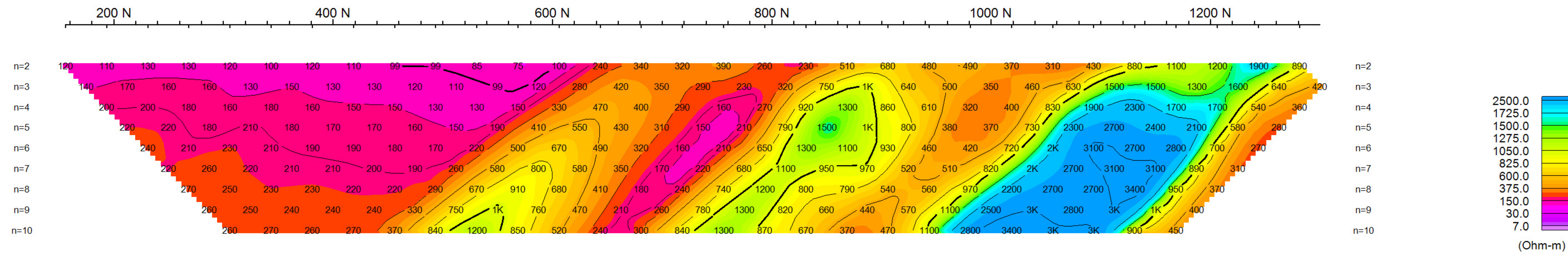

APPARENT CHARGEABILITY PSEUDO SECTION

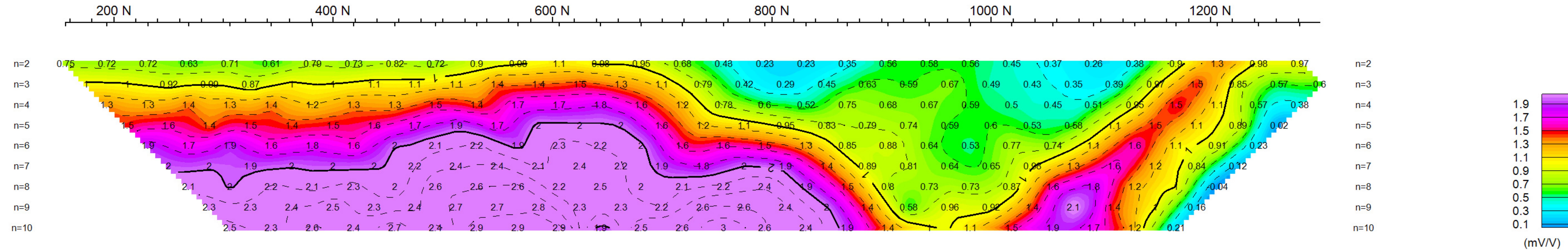

INTERPRETATION

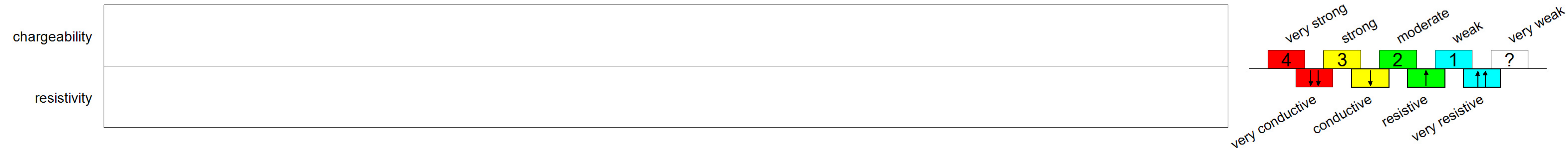

RESISTIVITY TRUE DEPTH SECTION

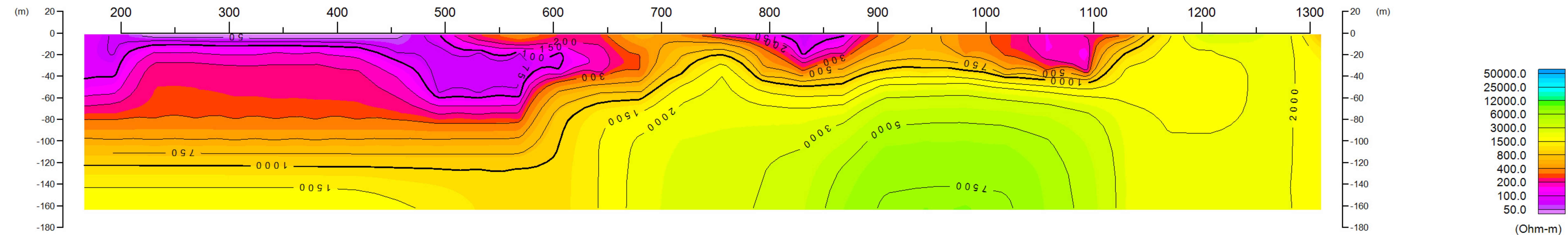

CHARGEABILITY TRUE DEPTH SECTION

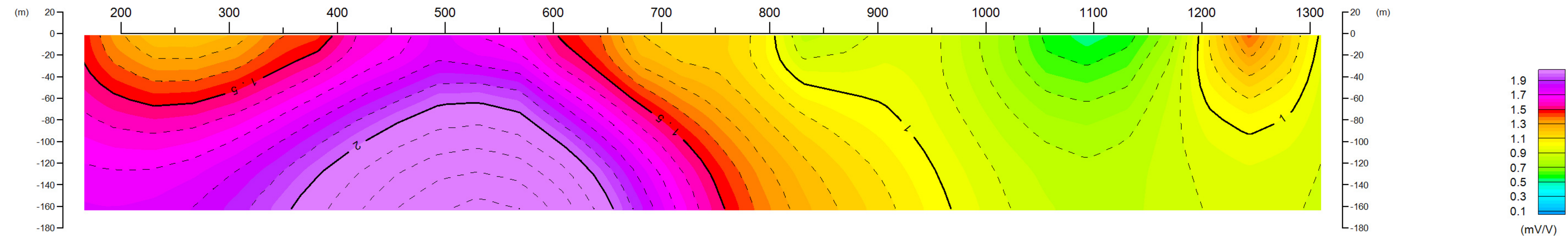

INDUCED POLARIZATION SURVEY

Pole-Dipole

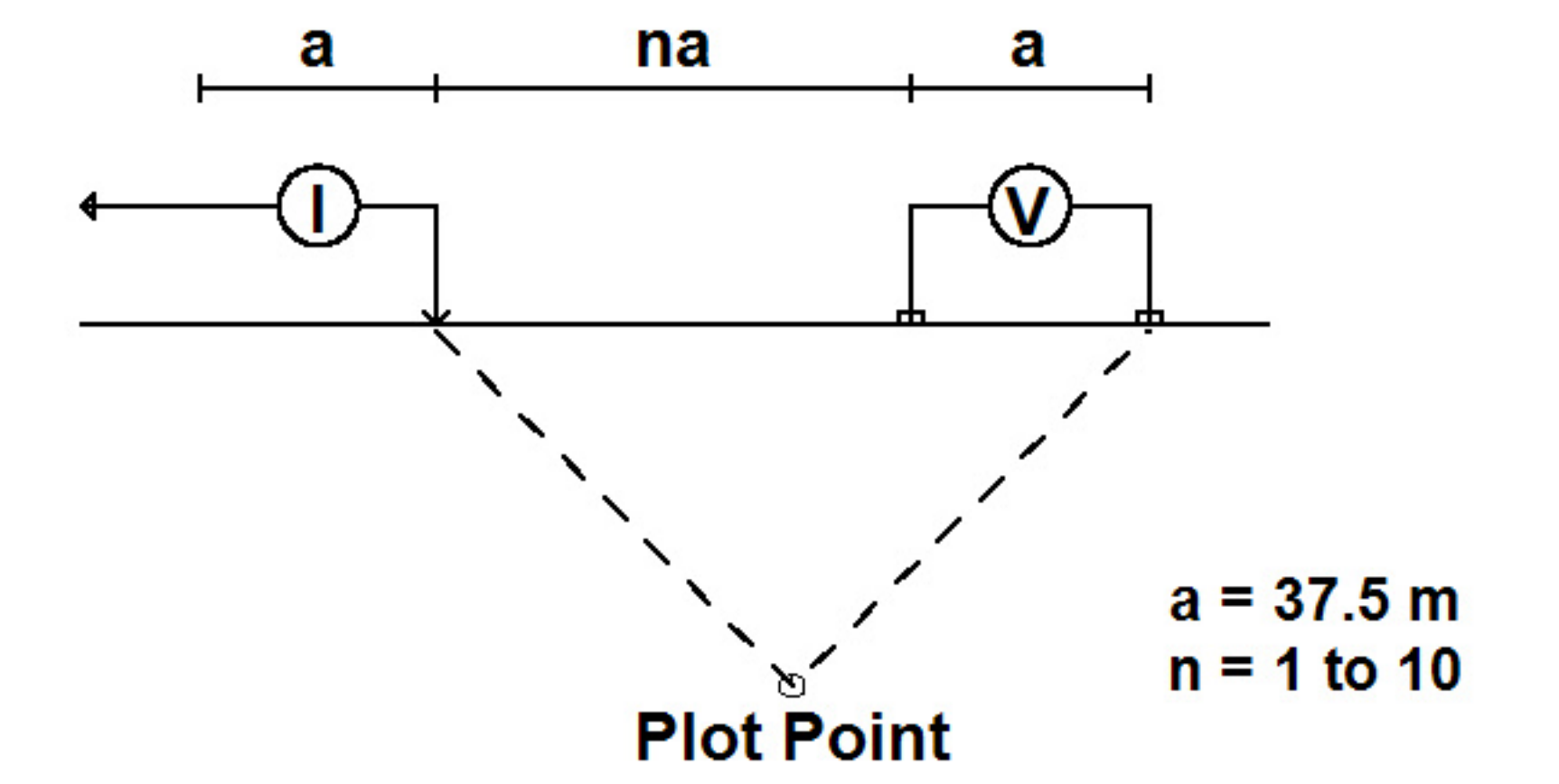

Transmitter: TXII, GDD Instrumentation

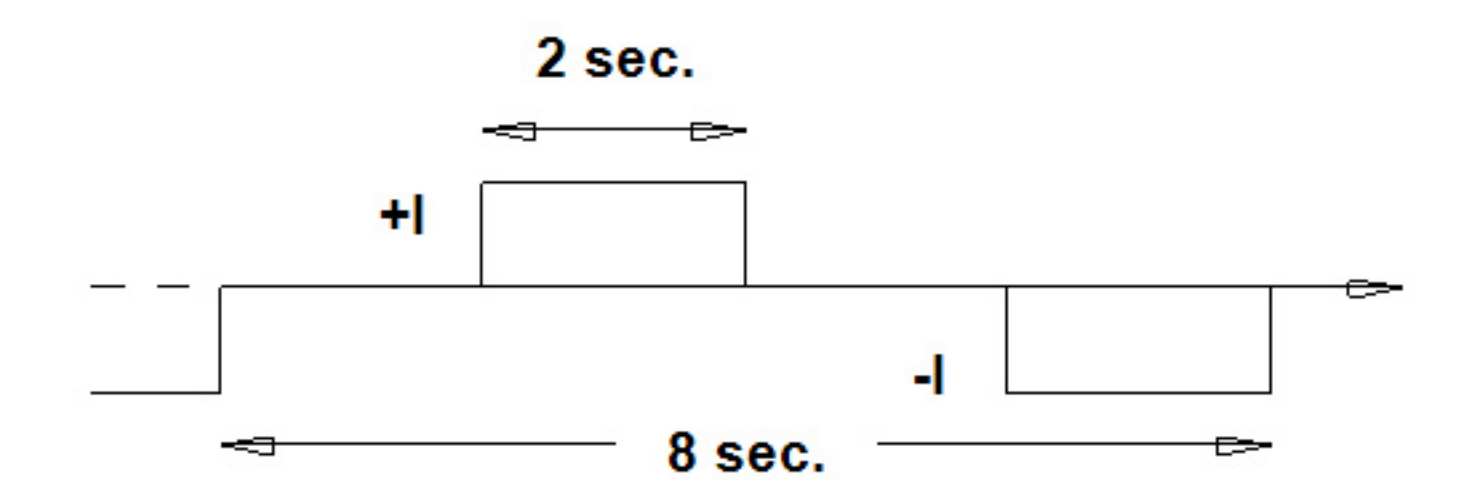

Receiver: Elrec Pro, Iris Instruments

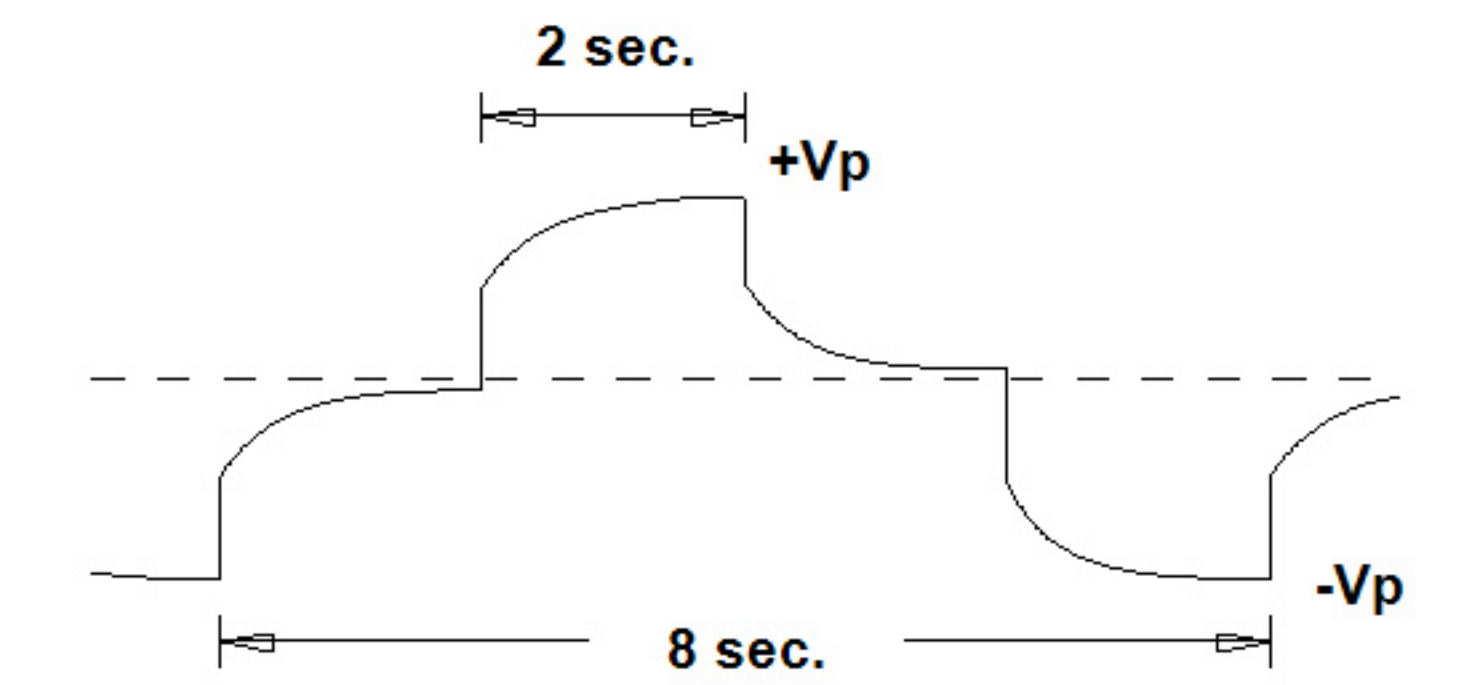

inversion **RES2DINV™**

Scale 1:5000

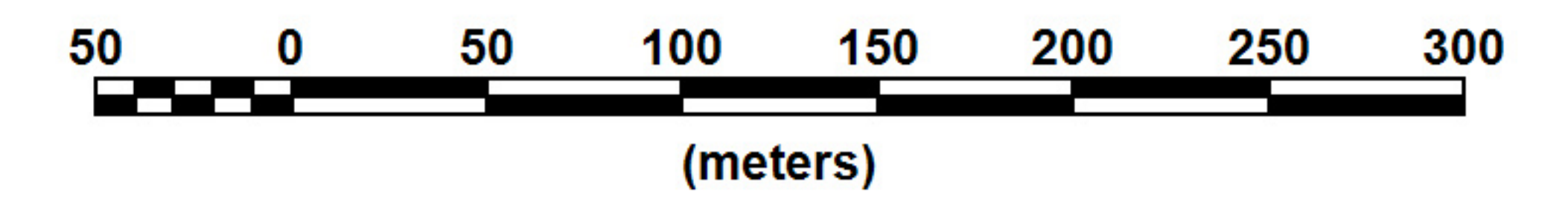

O3 MINING INC.

**SISCOE PROJECT
VASSAN TOWNSHIP
VAL D'OR, QUEBEC**

Line 800E

Interpreted by: Joël Simard, P.Geol./Geoph.
Verified by: Joël Simard, P.Geol./Geoph.
Surveyed by: J. Melançon
Date: January 2024
Ref: 24C672



APPARENT RESISTIVITY PSEUDO SECTION



APPARENT CHARGEABILITY PSEUDO SECTION



INTERPRETATION

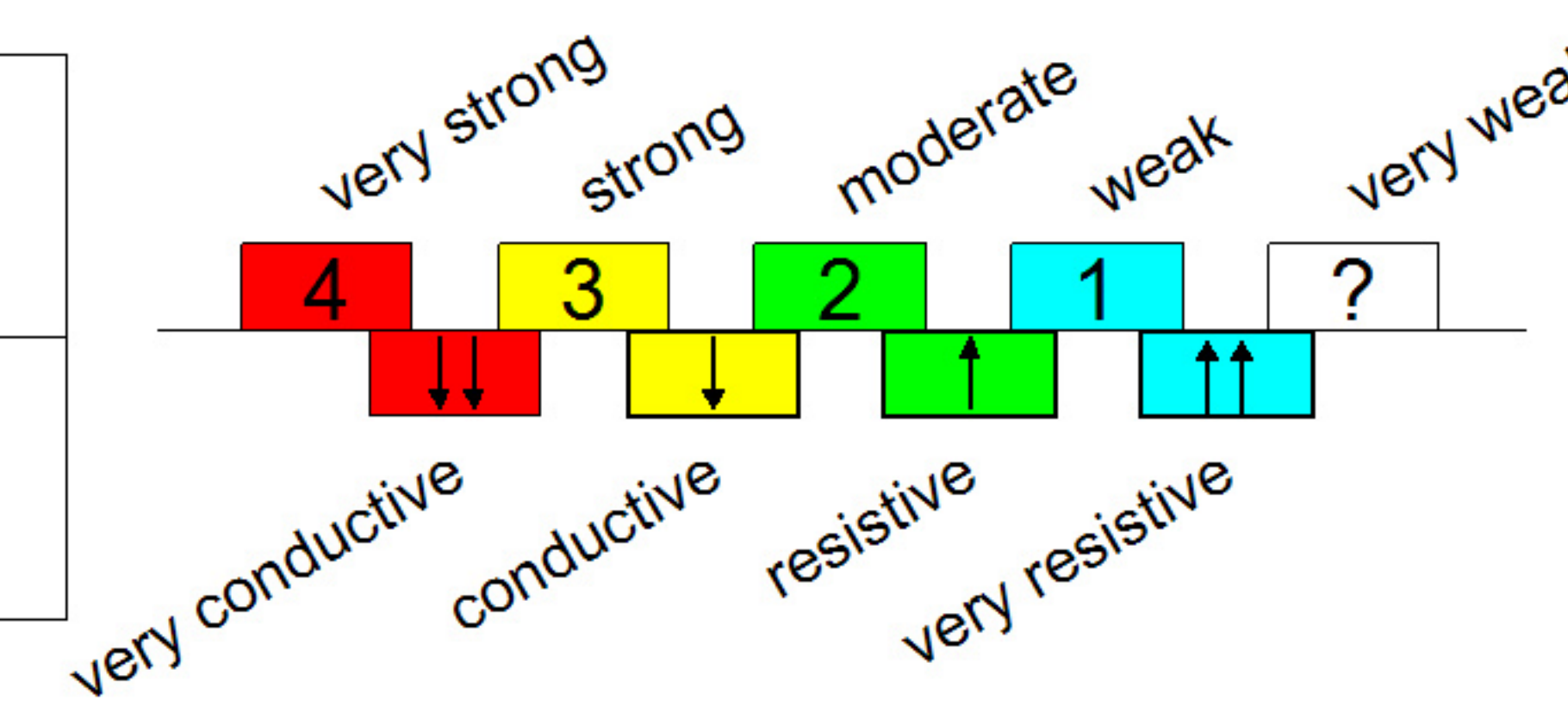


RESISTIVITY TRUE DEPTH SECTION



CHARGEABILITY TRUE DEPTH SECTION



INDUCED POLARIZATION SURVEY

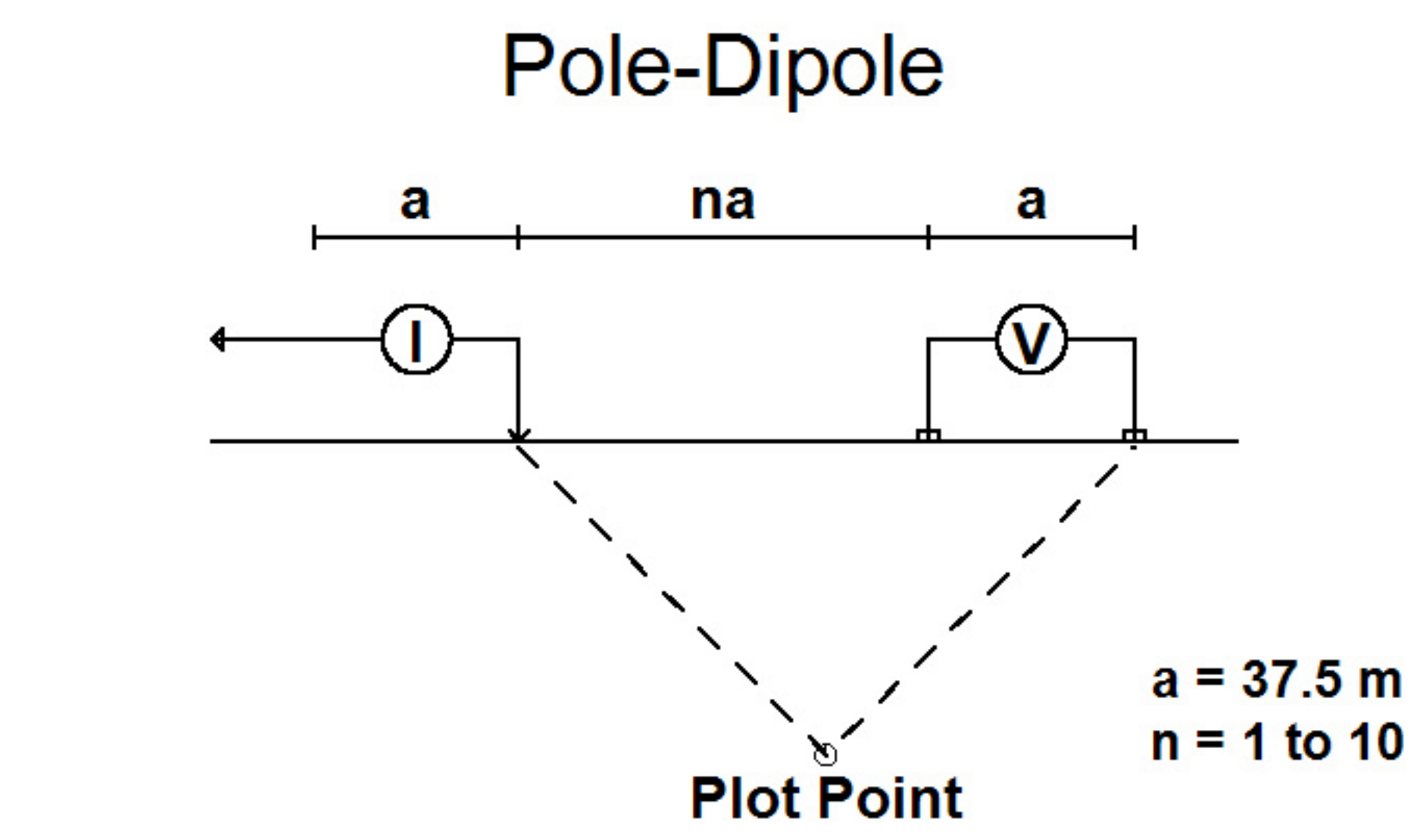

Transmitter: TXII, GDD Instrumentation

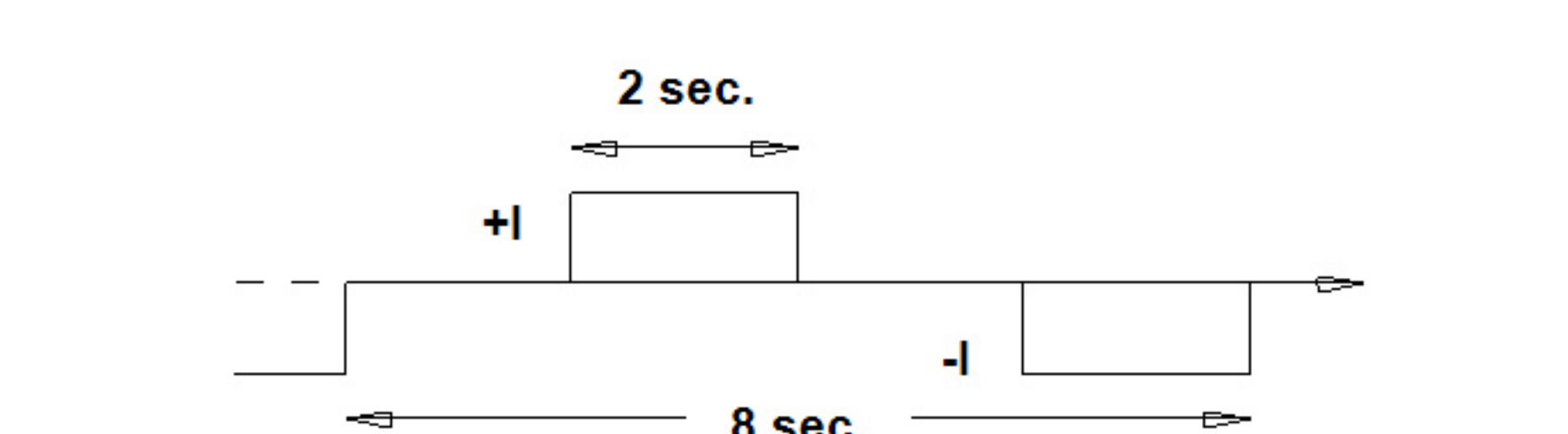

Receiver: Elrec Pro, Iris Instruments

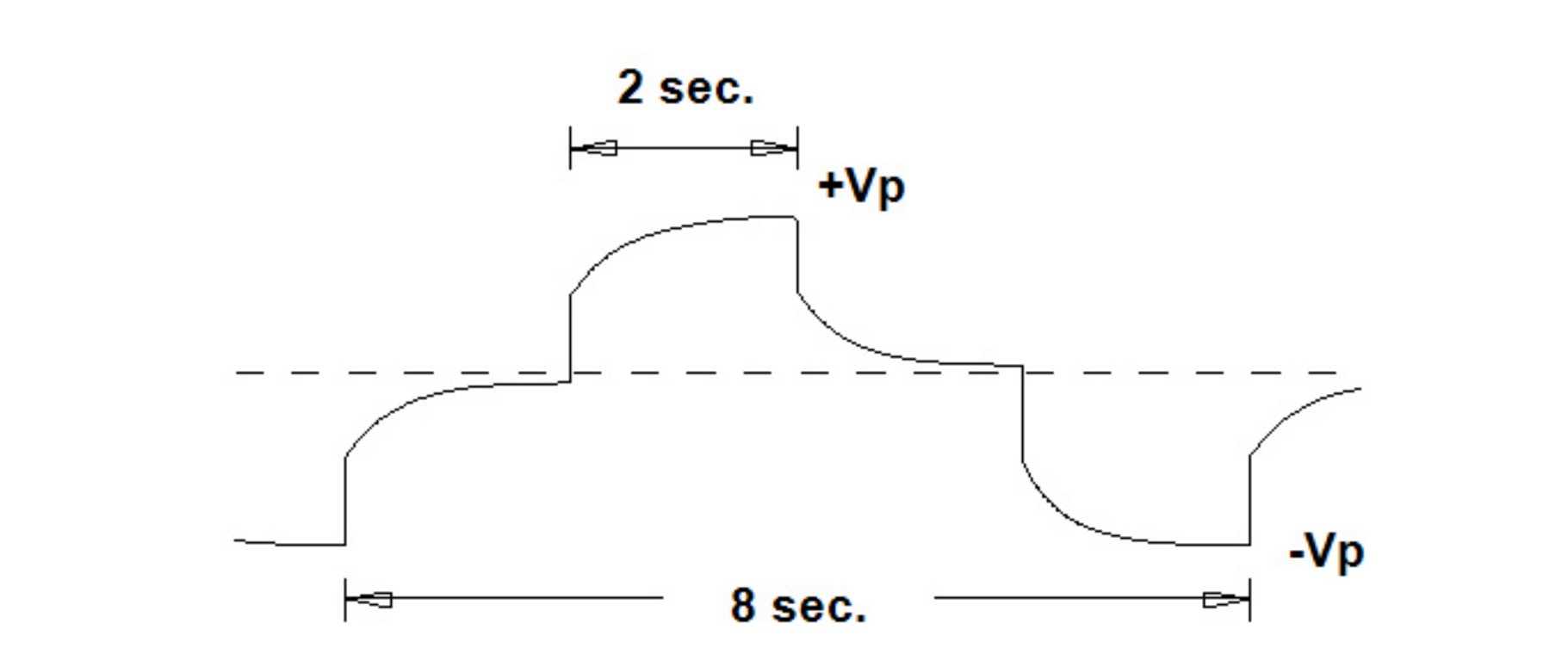

inversion **RES2DINV™**

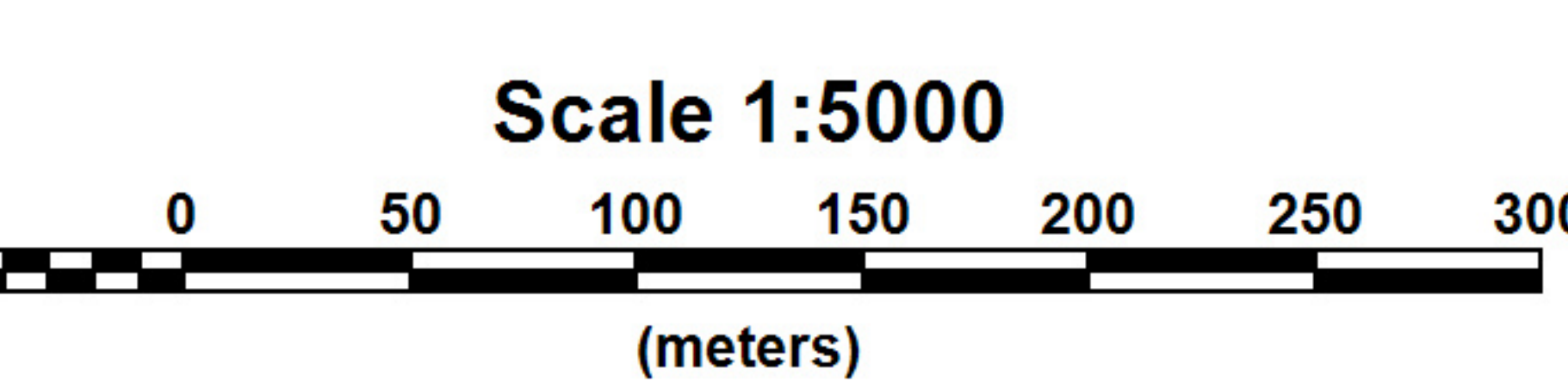

O3 MINING INC.

SISCOE PROJECT
VASSAN TOWNSHIP
VAL D'OR, QUEBEC

Line 1200E

Interpreted by: Joël Simard, P.Geol./Geoph.
Verified by: Joël Simard, P.Geol./Geoph.
Surveyed by: J. Melançon
Date: January 2024
Ref: 24C672



APPARENT RESISTIVITY PSEUDO SECTION



APPARENT CHARGEABILITY PSEUDO SECTION



INTERPRETATION

chargeability	
resistivity	

RESISTIVITY TRUE DEPTH SECTION



CHARGEABILITY TRUE DEPTH SECTION

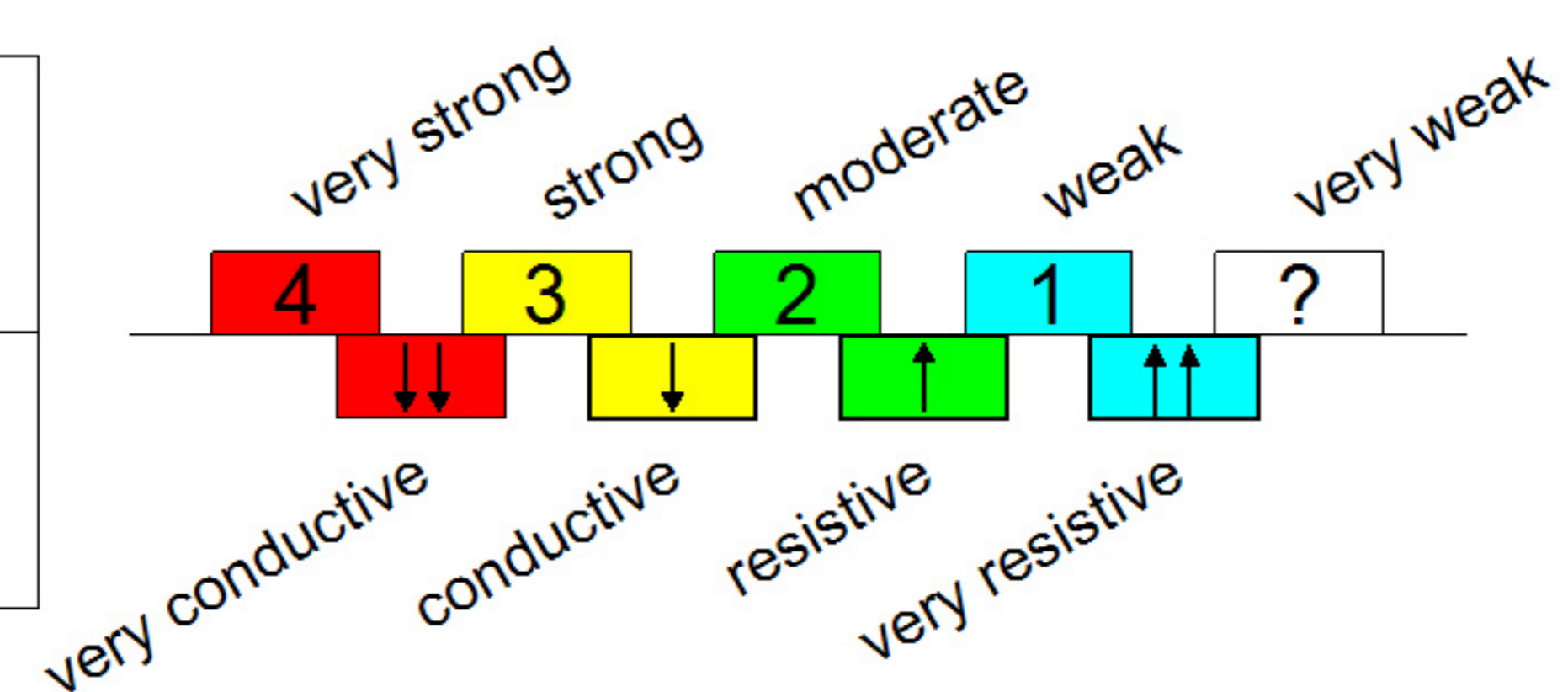
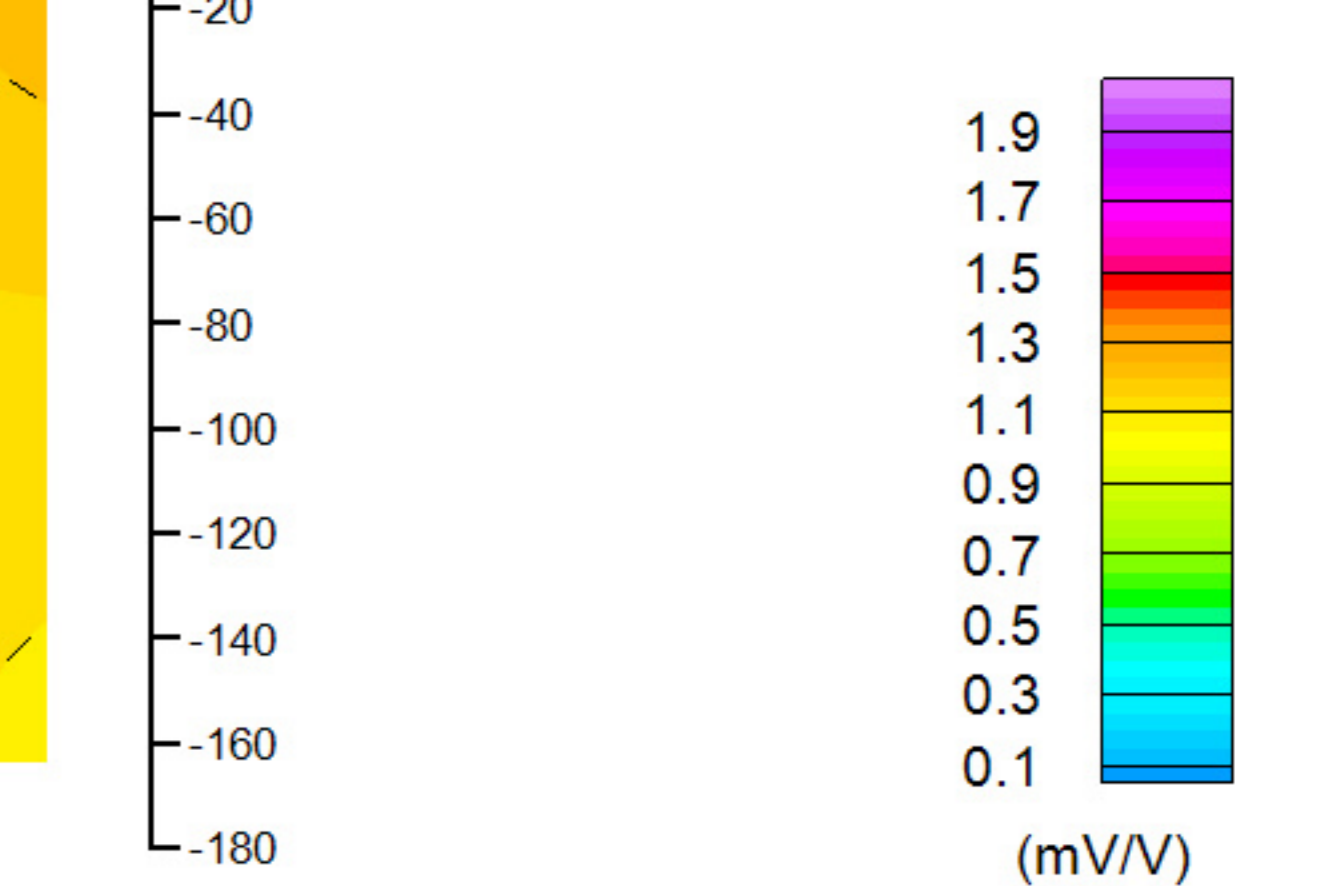
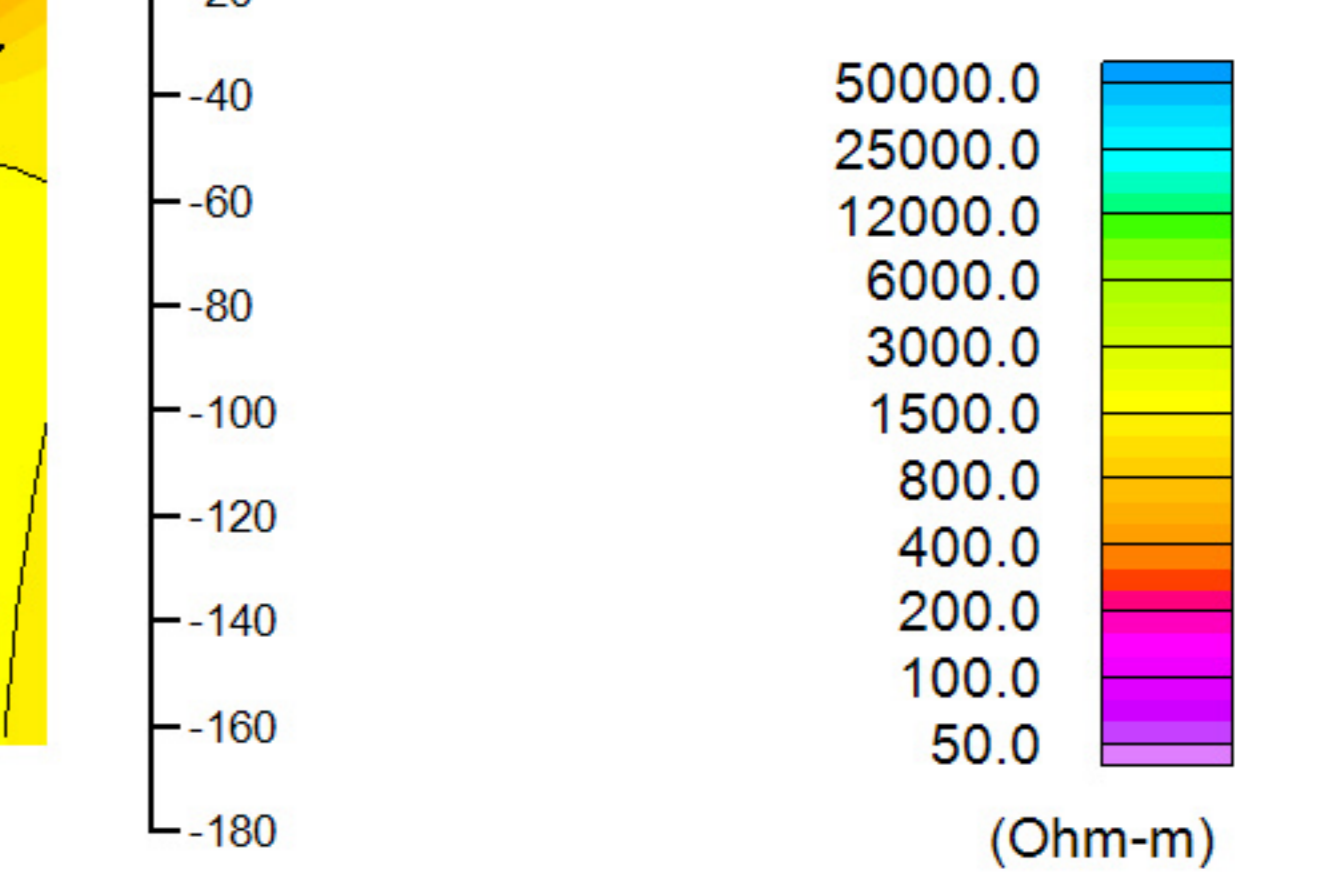
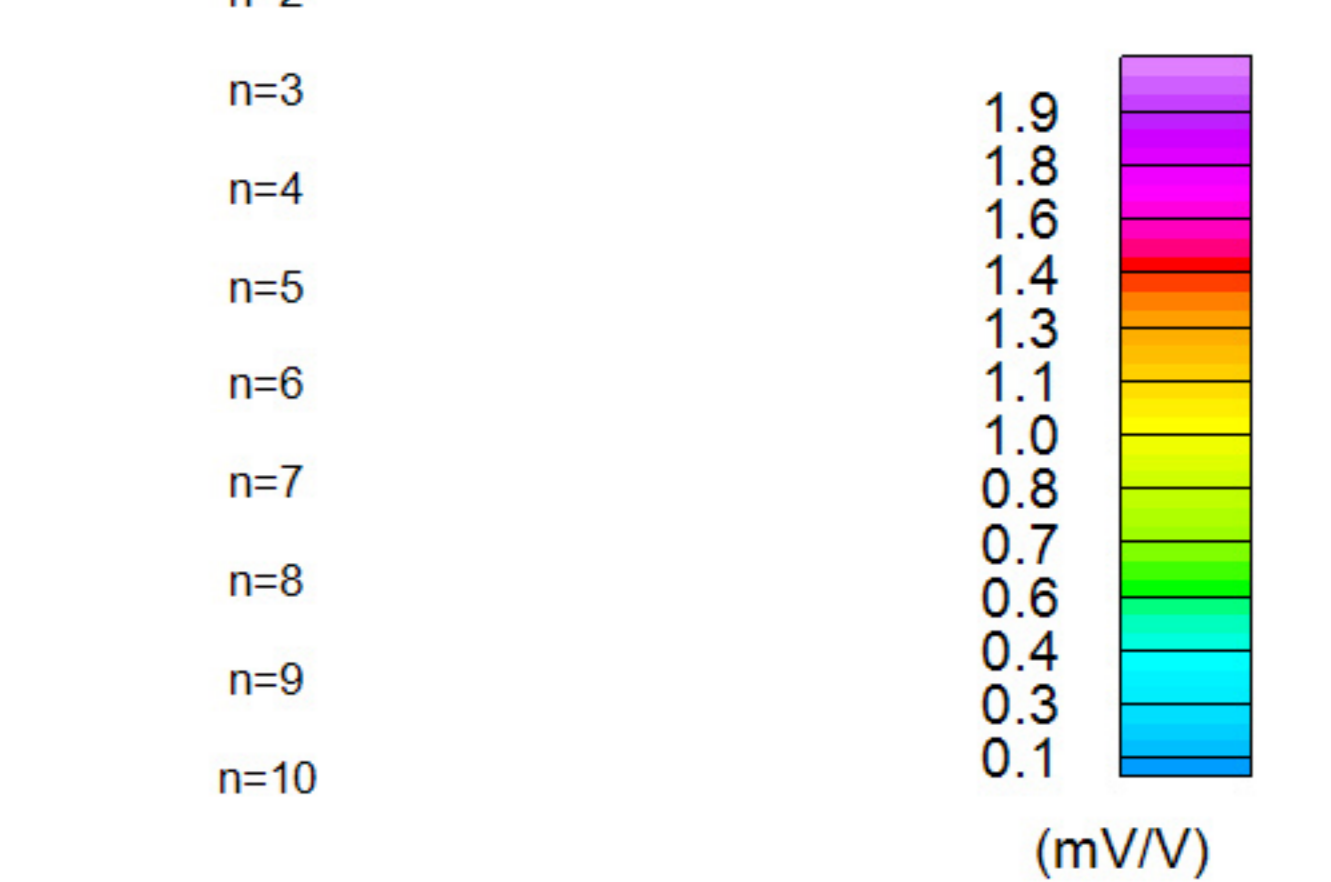
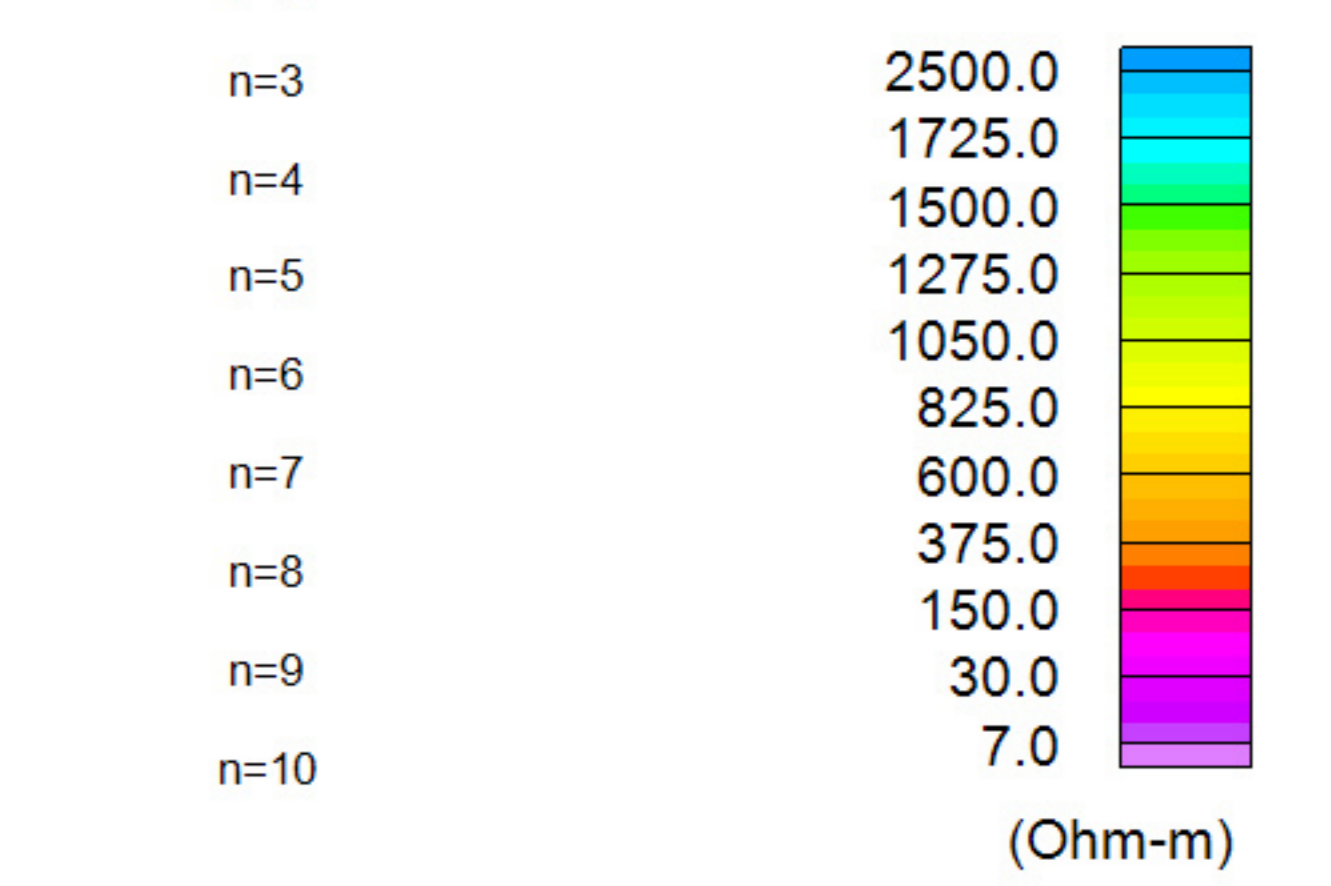


INDUCED POLARIZATION SURVEY

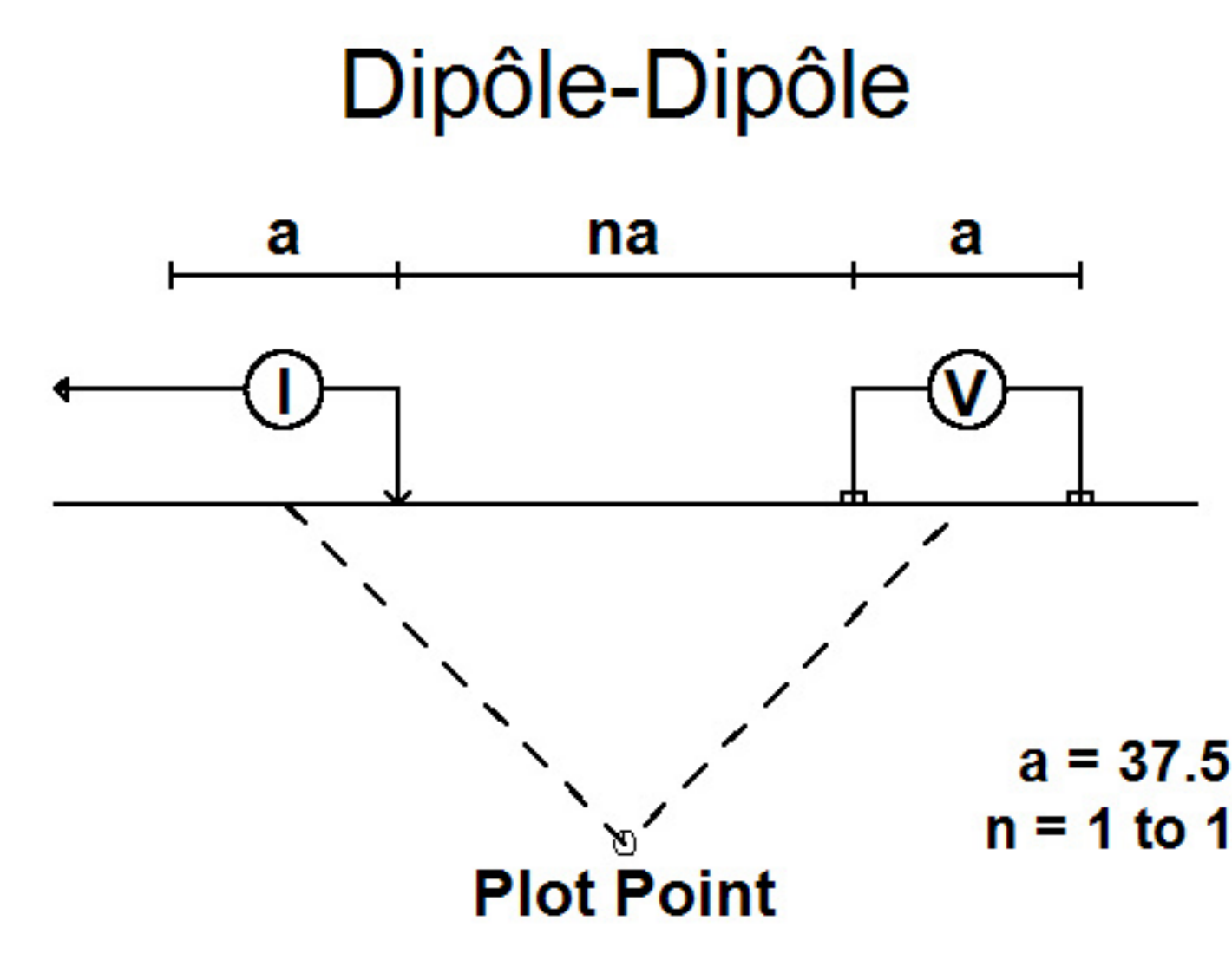

Transmitter: TXII, GDD Instrumentation

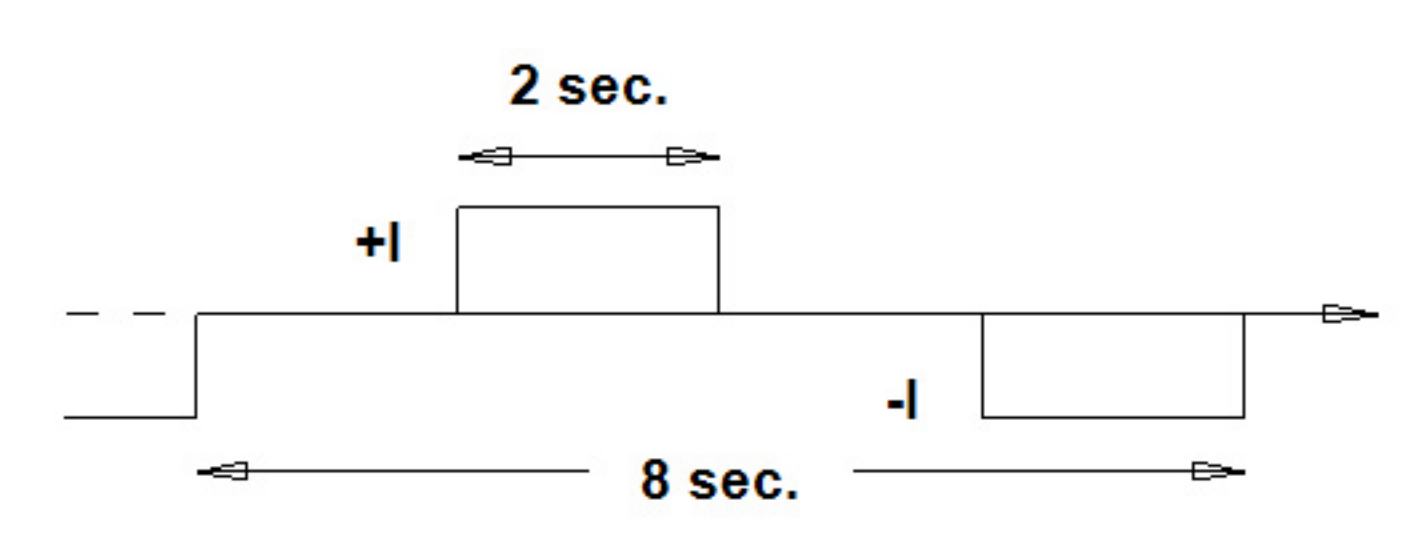

Receiver: Elrec Pro, Iris Instruments

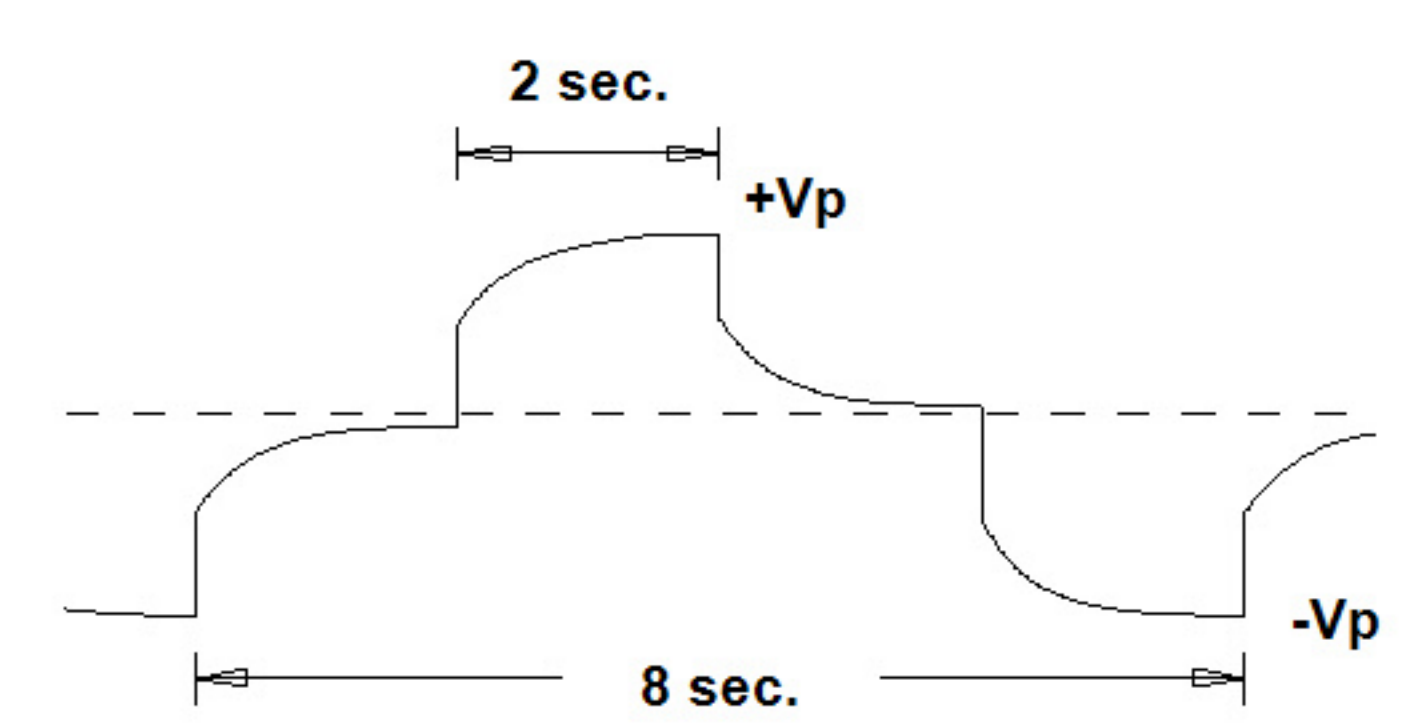

inversion **RES2DINV™**

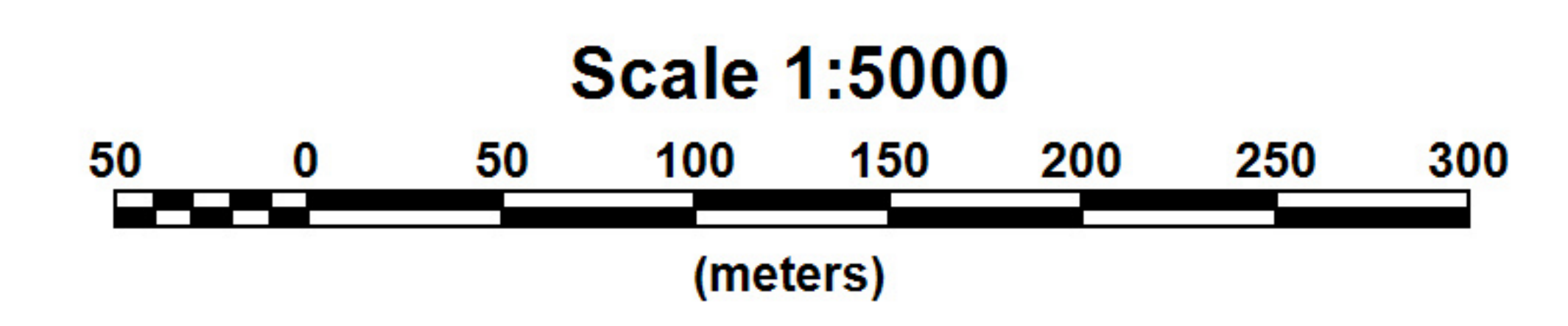

O3 MINING INC.

**SISCOE PROJECT
VASSAN TOWNSHIP
VAL D'OR, QUEBEC**

Line 1600E

Interpreted by: Joël Simard, P.Geol./Geoph.
Verified by: Joël Simard, P.Geol./Geoph.
Surveyed by: J. Melançon
Date: January 2024
Ref: 24C672



APPARENT RESISTIVITY PSEUDO SECTION



APPARENT CHARGEABILITY PSEUDO SECTION



INTERPRETATION

chargeability	
resistivity	

RESISTIVITY TRUE DEPTH SECTION



CHARGEABILITY TRUE DEPTH SECTION

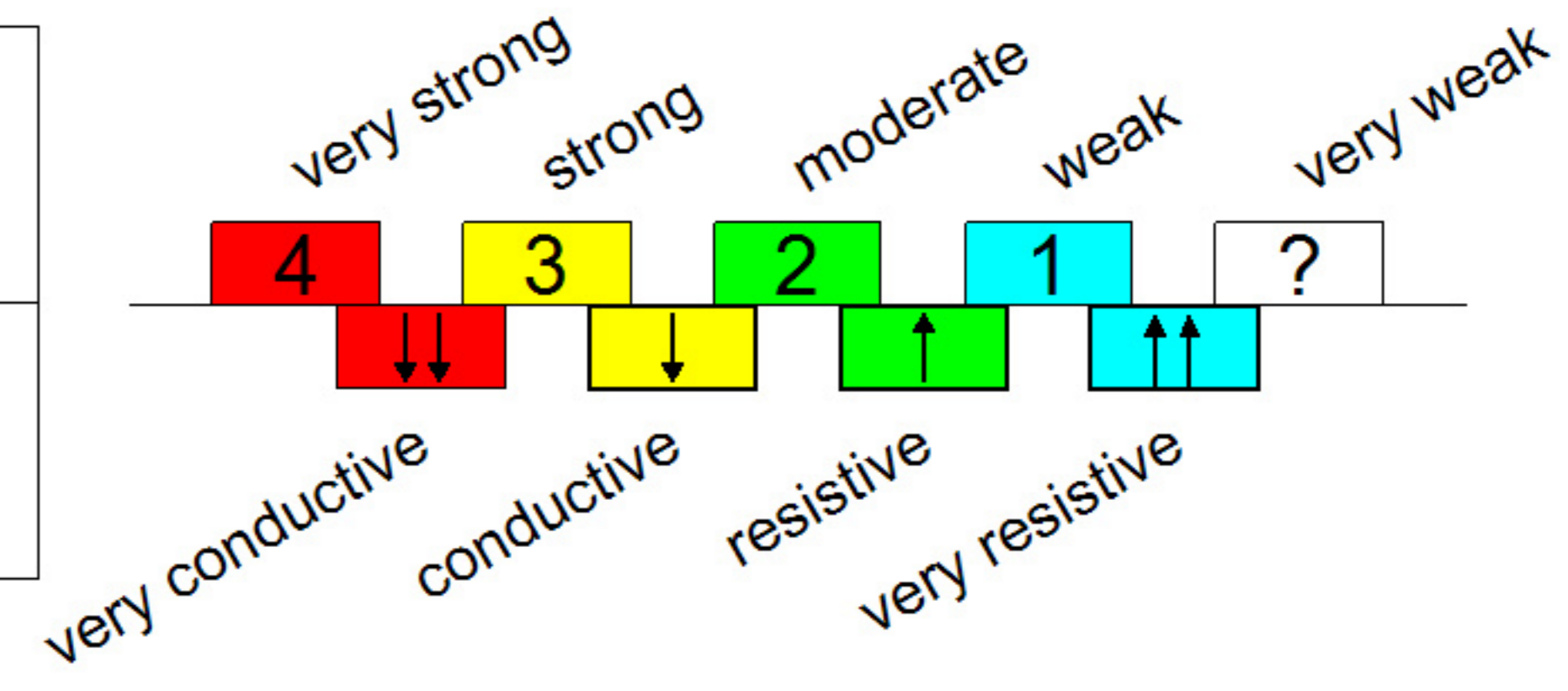


INDUCED POLARIZATION SURVEY

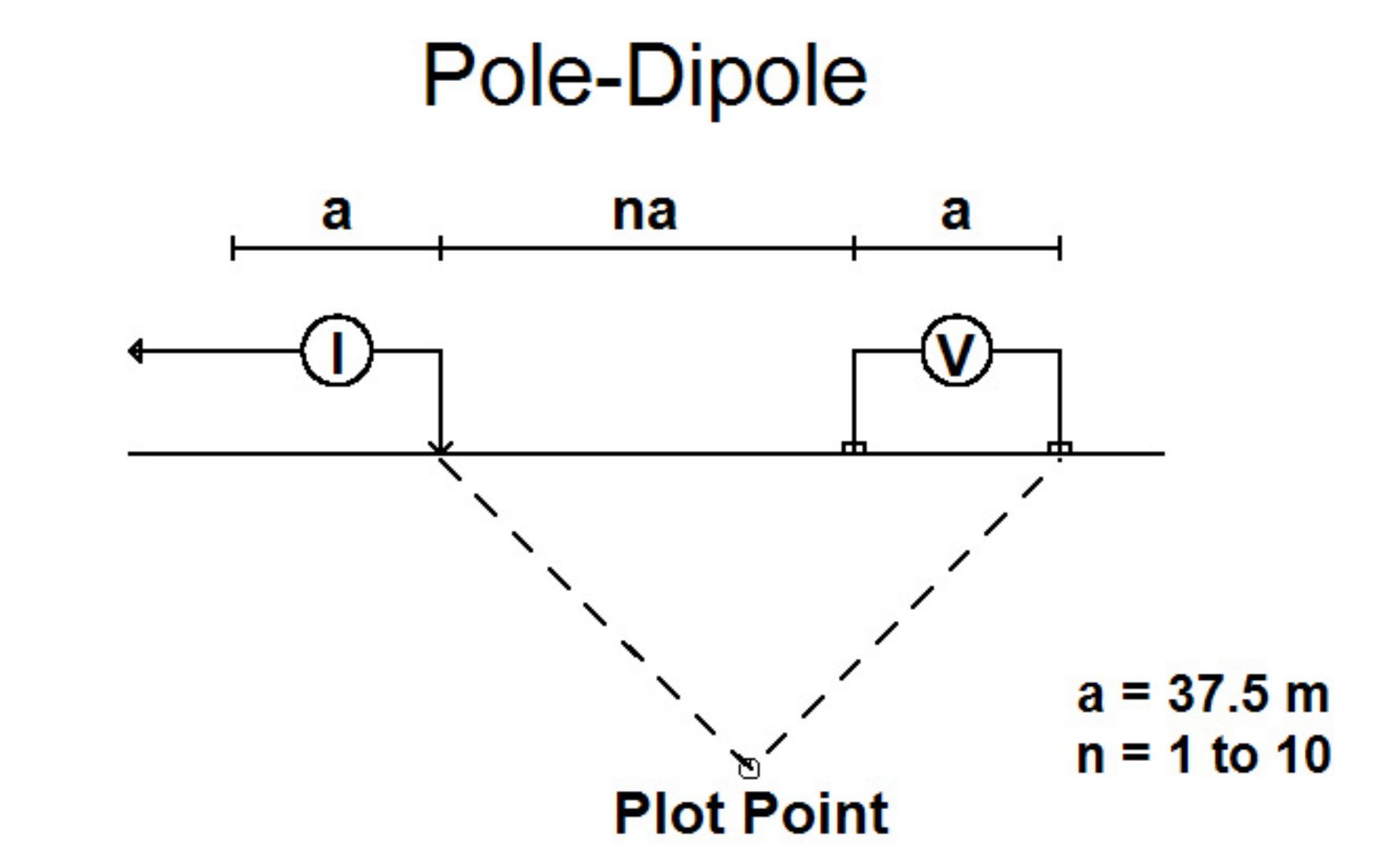

Transmitter: TXII, GDD Instrumentation

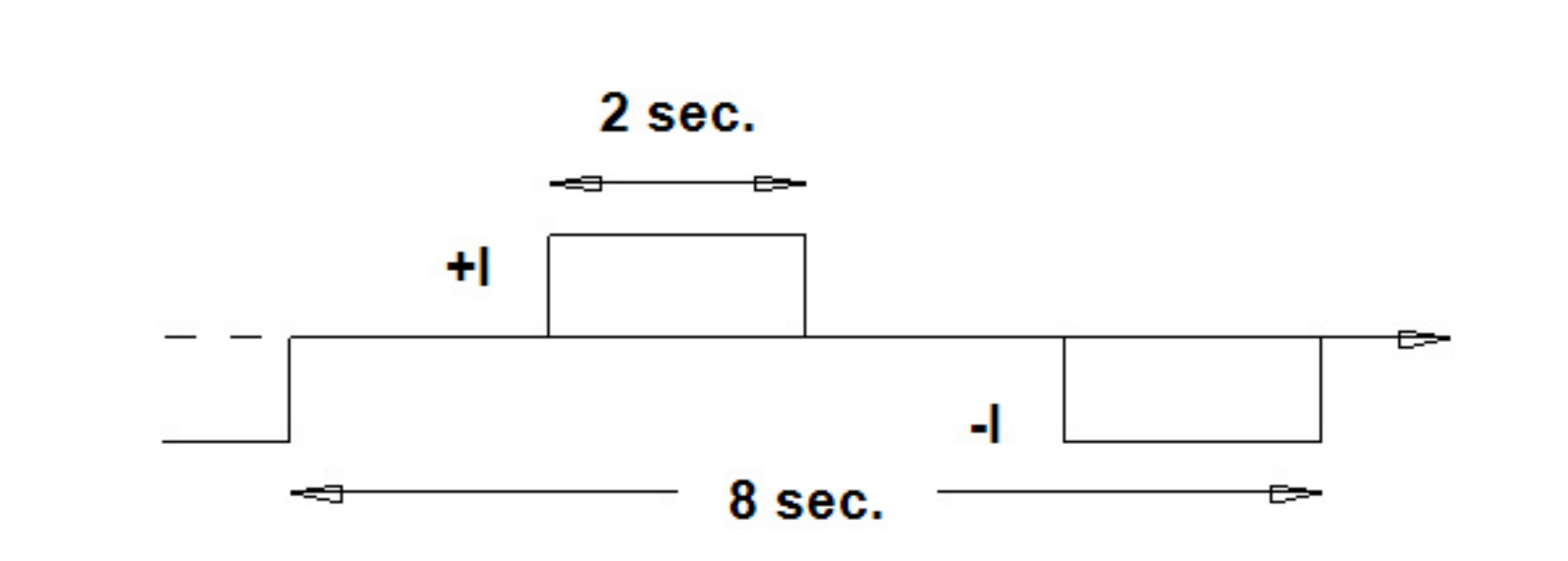

Receiver: Elrec Pro, Iris Instruments

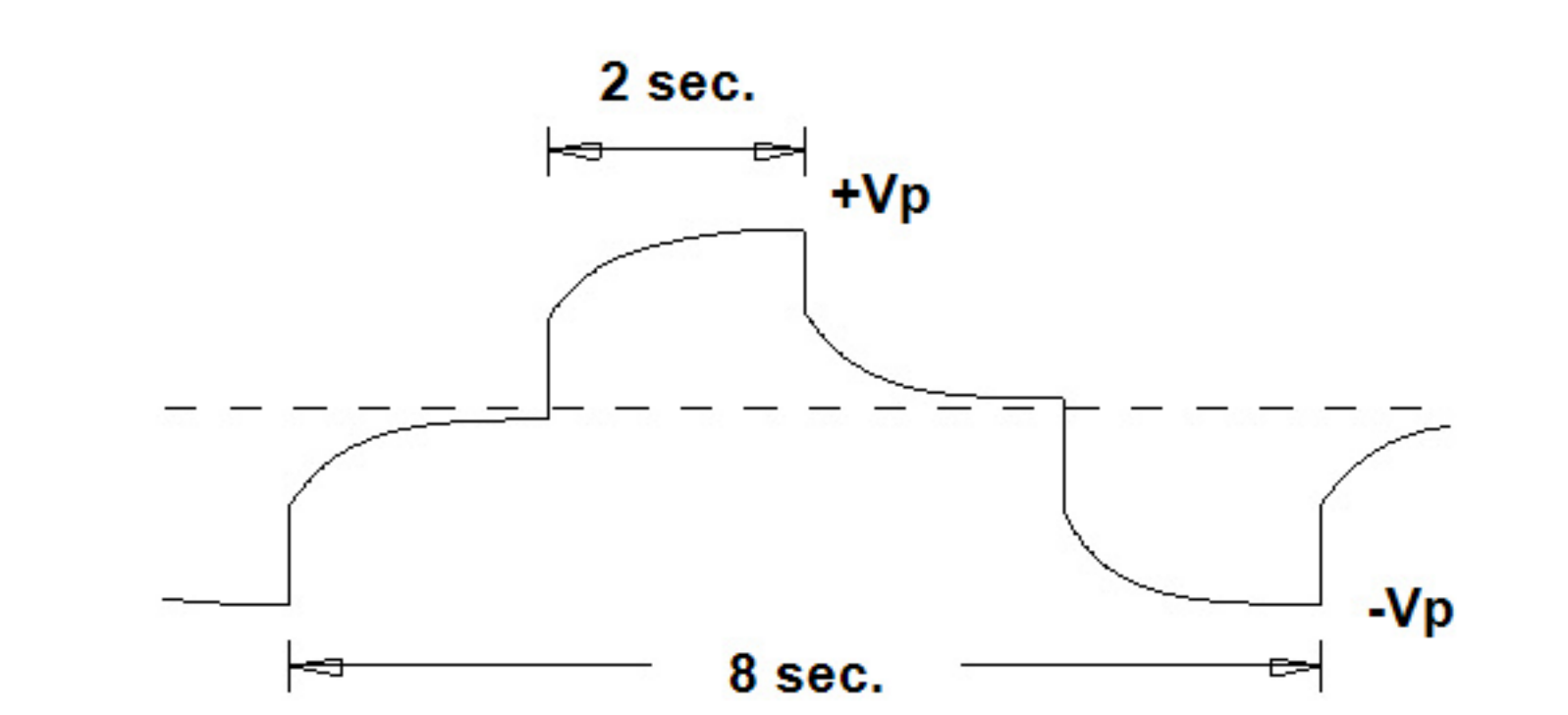

inversion **RES2DINV™**

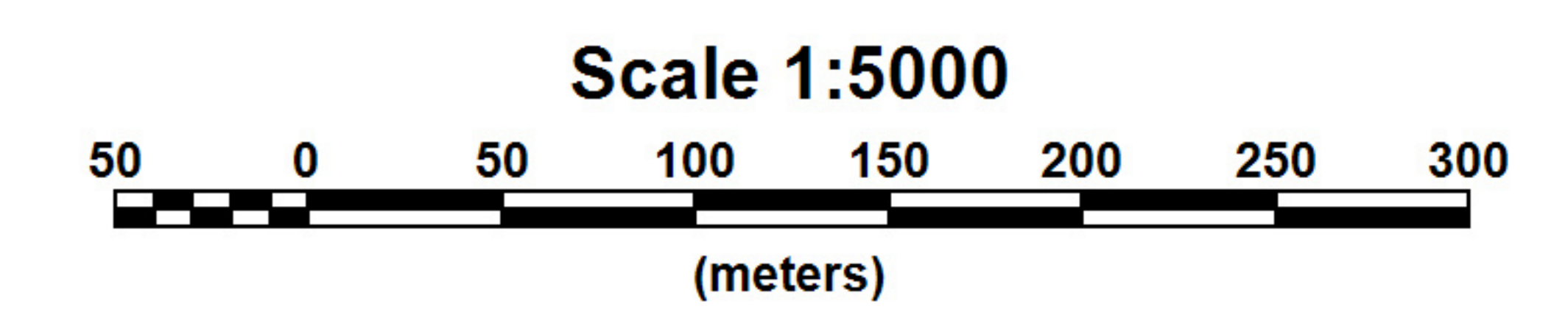

O3 MINING INC.

SISCOE PROJECT
VASSAN TOWNSHIP
VAL D'OR, QUEBEC

Line 2000E

Interpreted by: Joël Simard, P.Geol./Geoph.
 Verified by: Joël Simard, P.Geol./Geoph.
 Surveyed by: J. Melançon
 Date: January 2024
 Ref: 24C672

APPARENT RESISTIVITY PSEUDO SECTION



APPARENT CHARGEABILITY PSEUDO SECTION



INTERPRETATION

chargeability	
resistivity	

RESISTIVITY TRUE DEPTH SECTION



CHARGEABILITY TRUE DEPTH SECTION

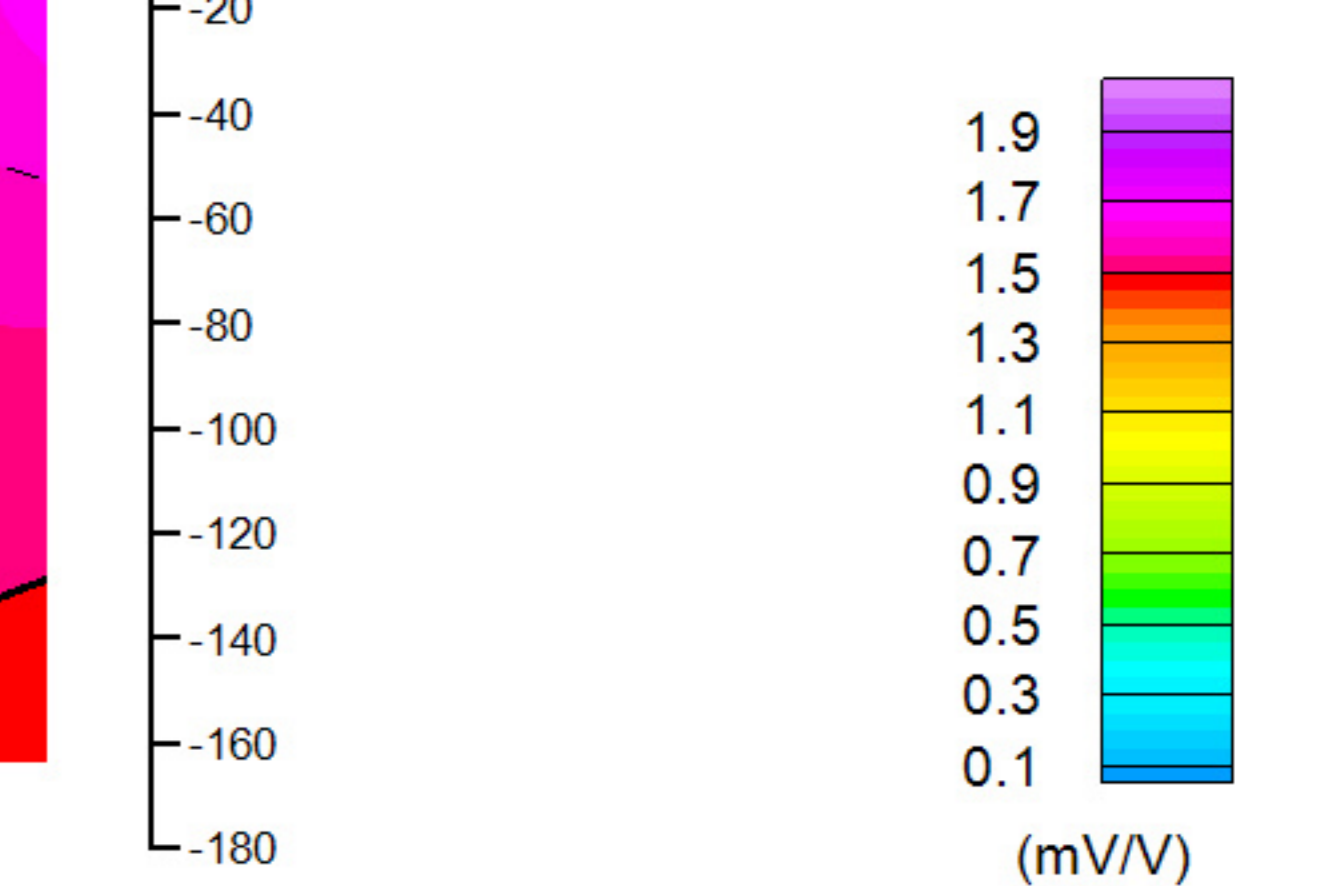
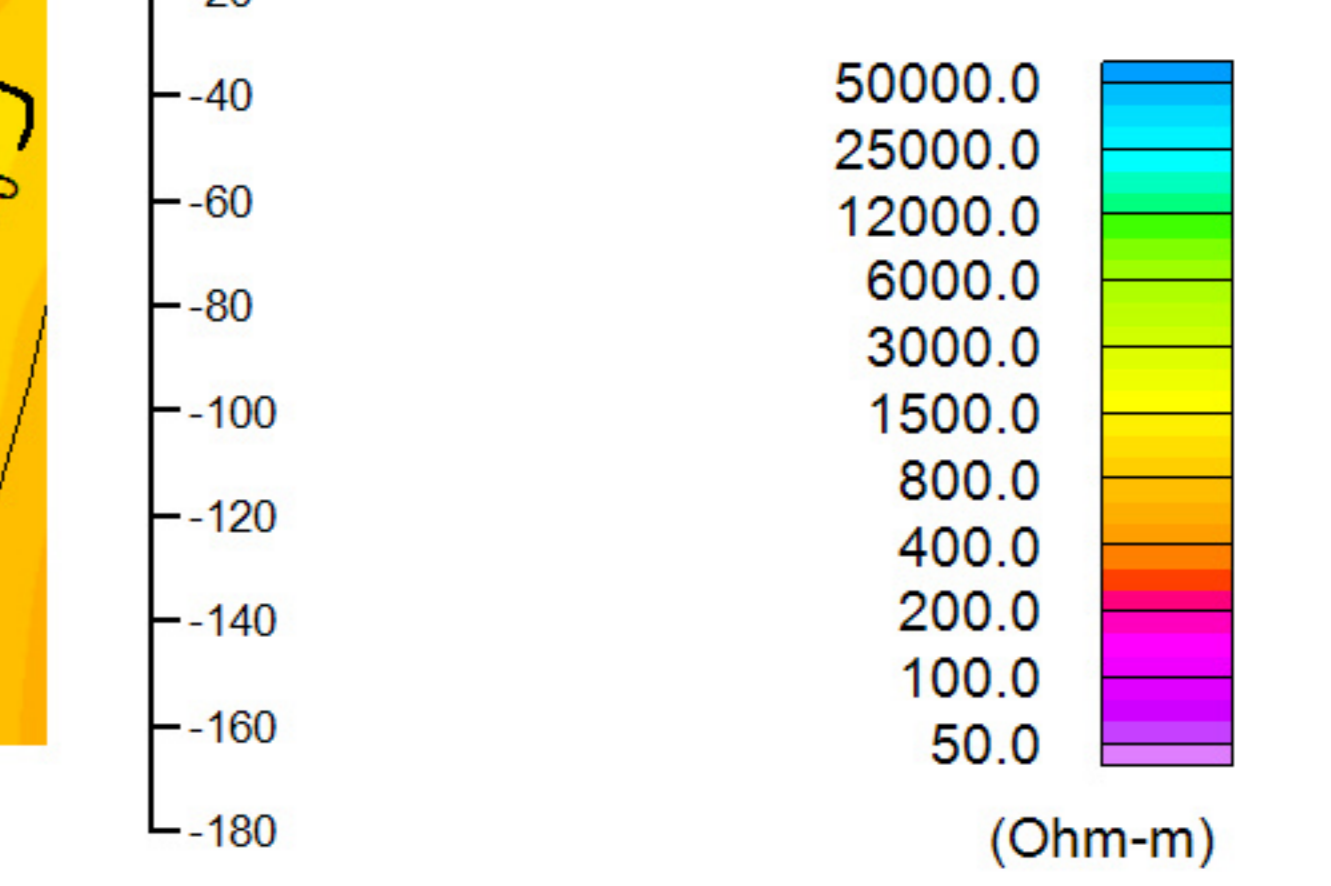
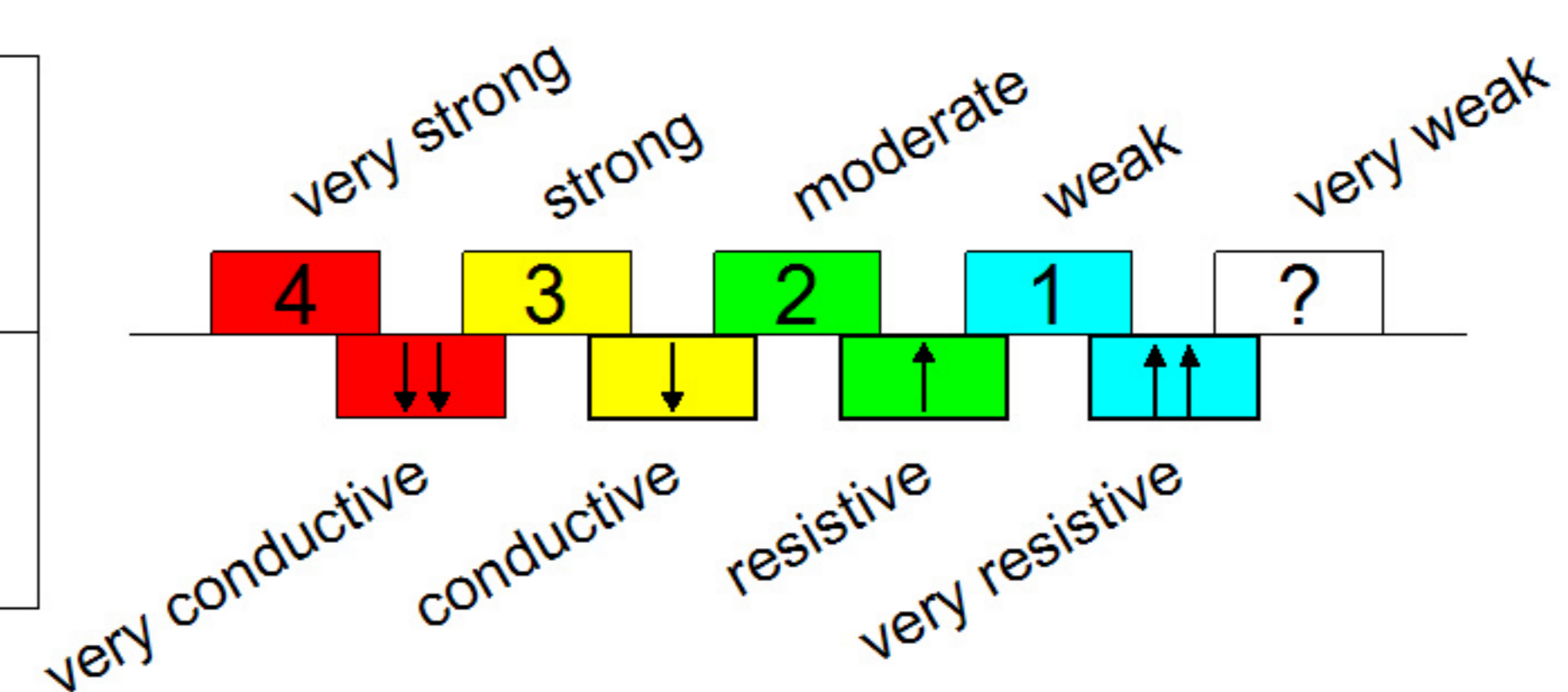
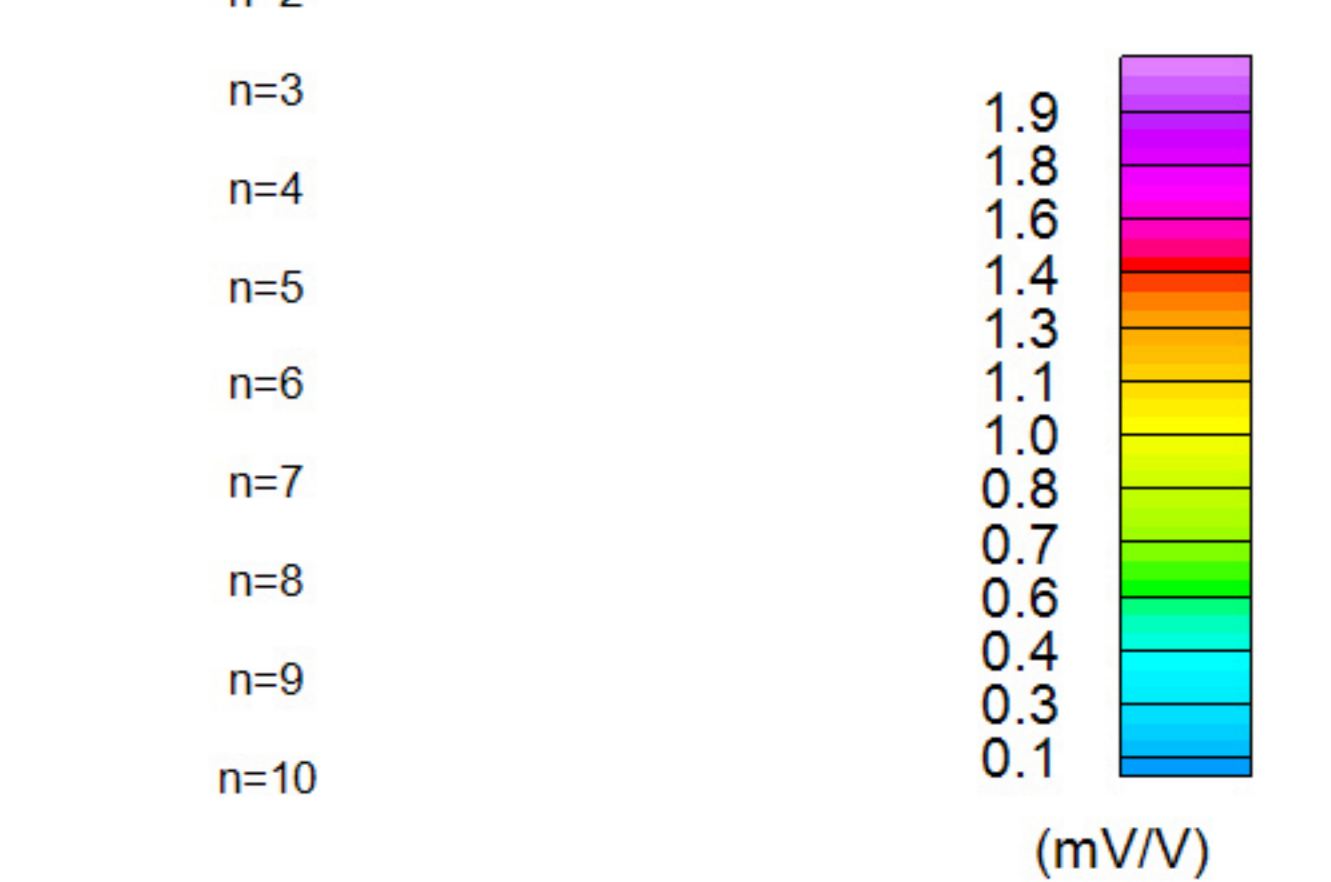
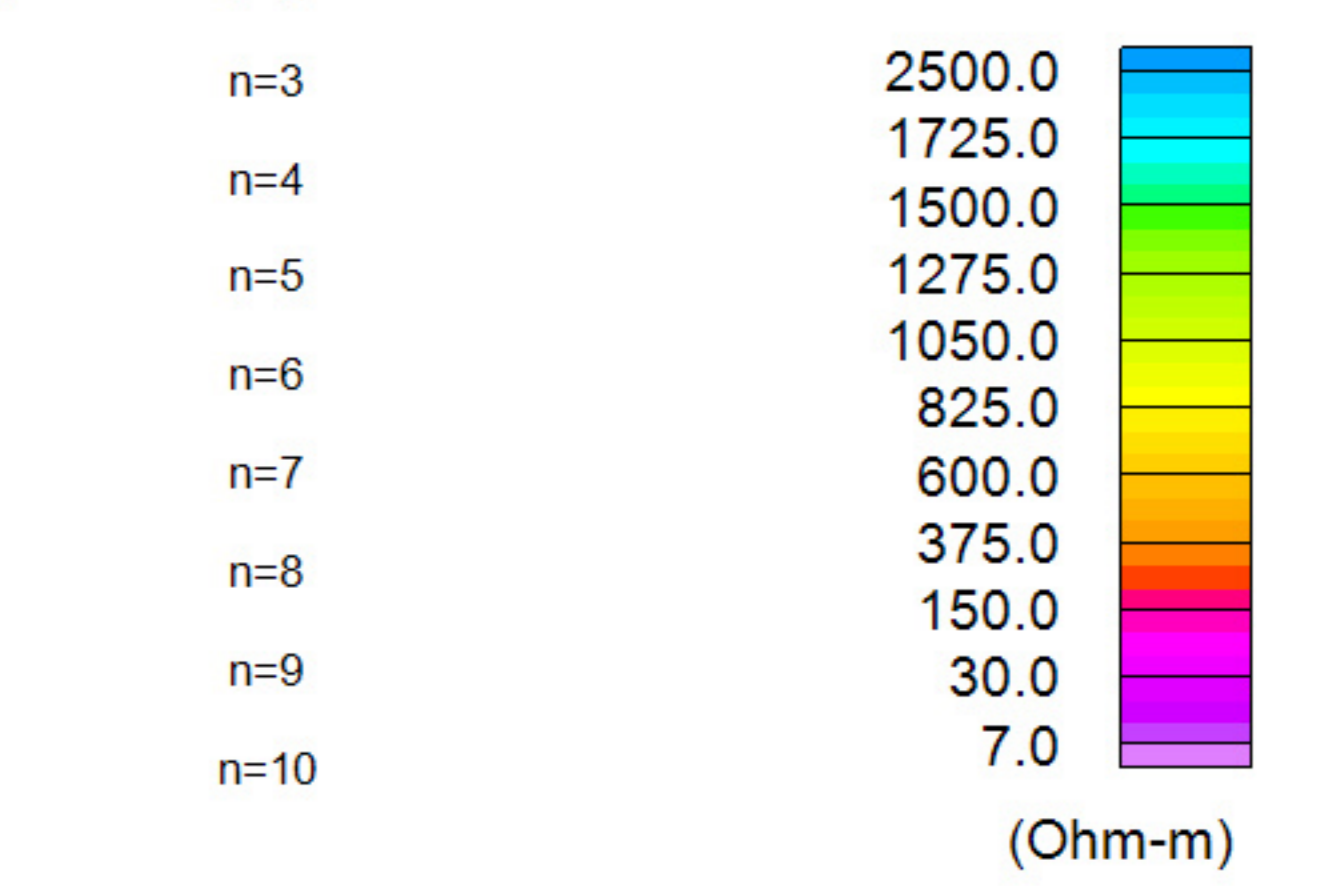


INDUCED POLARIZATION SURVEY

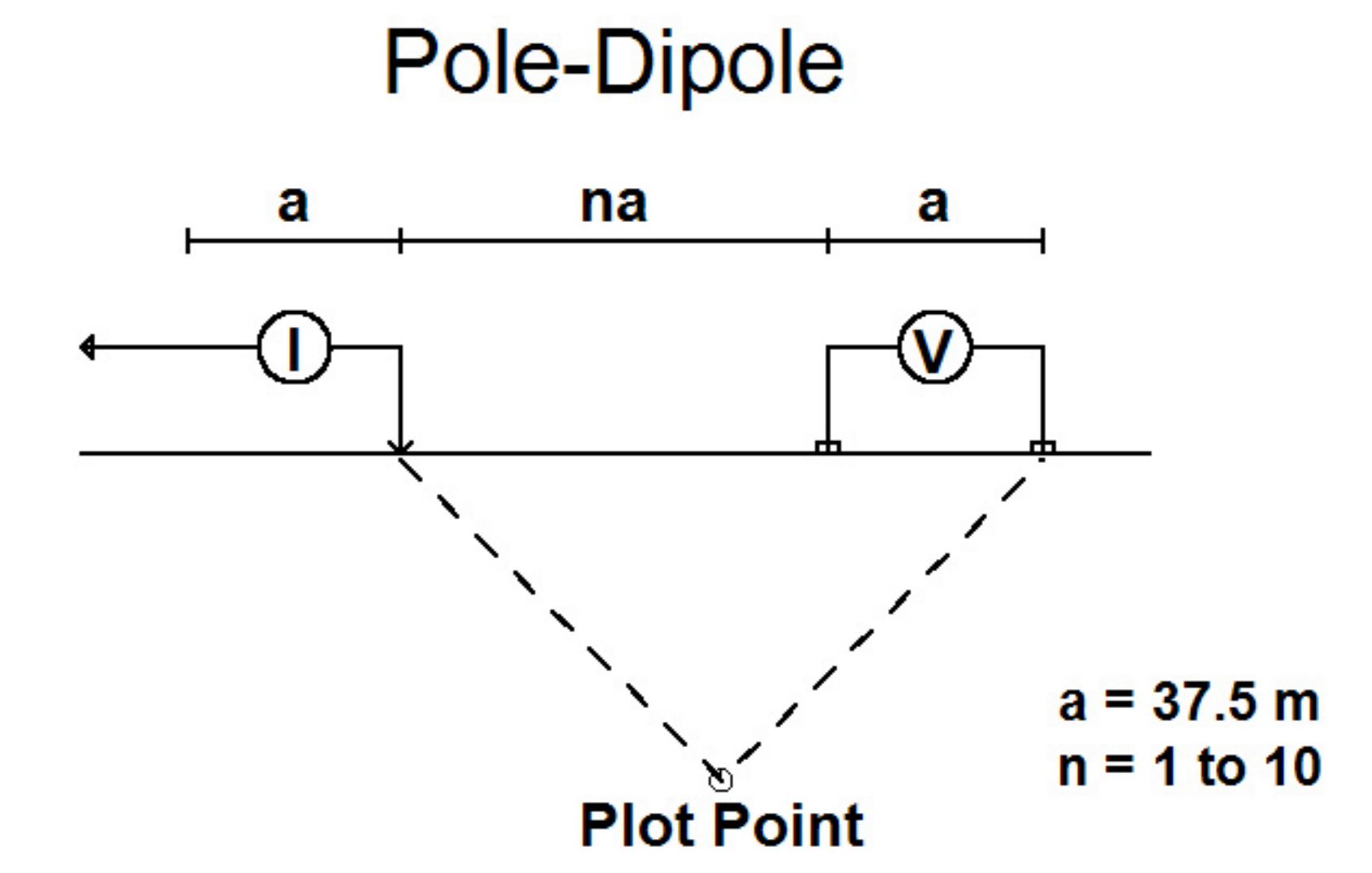

Transmitter: TXII, GDD Instrumentation

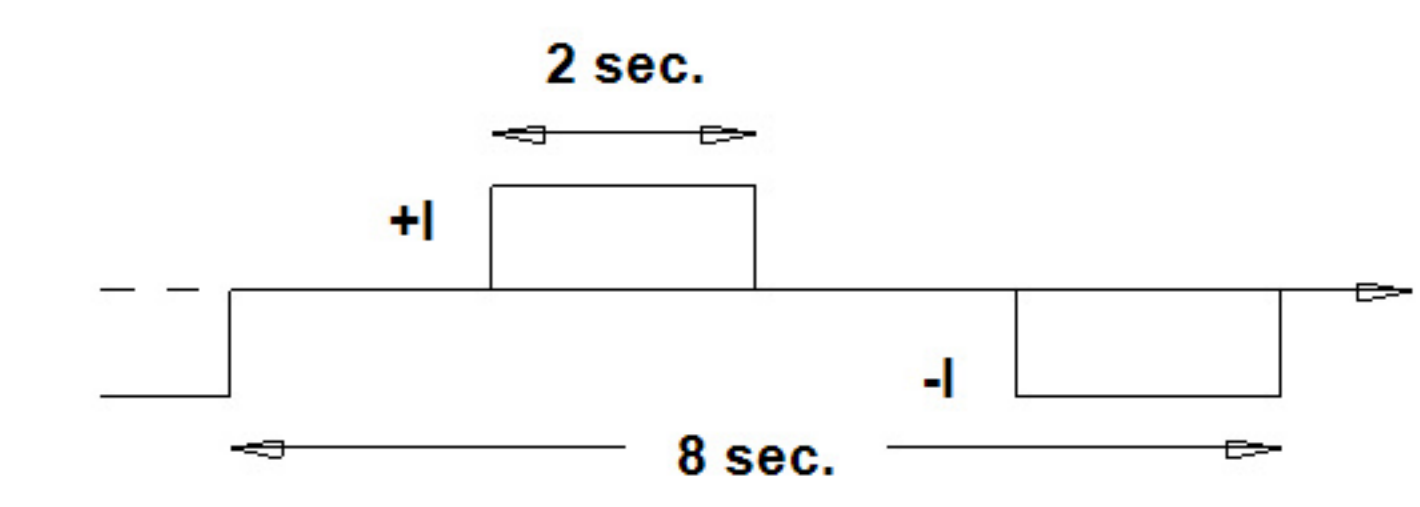

Receiver: Elrec Pro, Iris Instruments

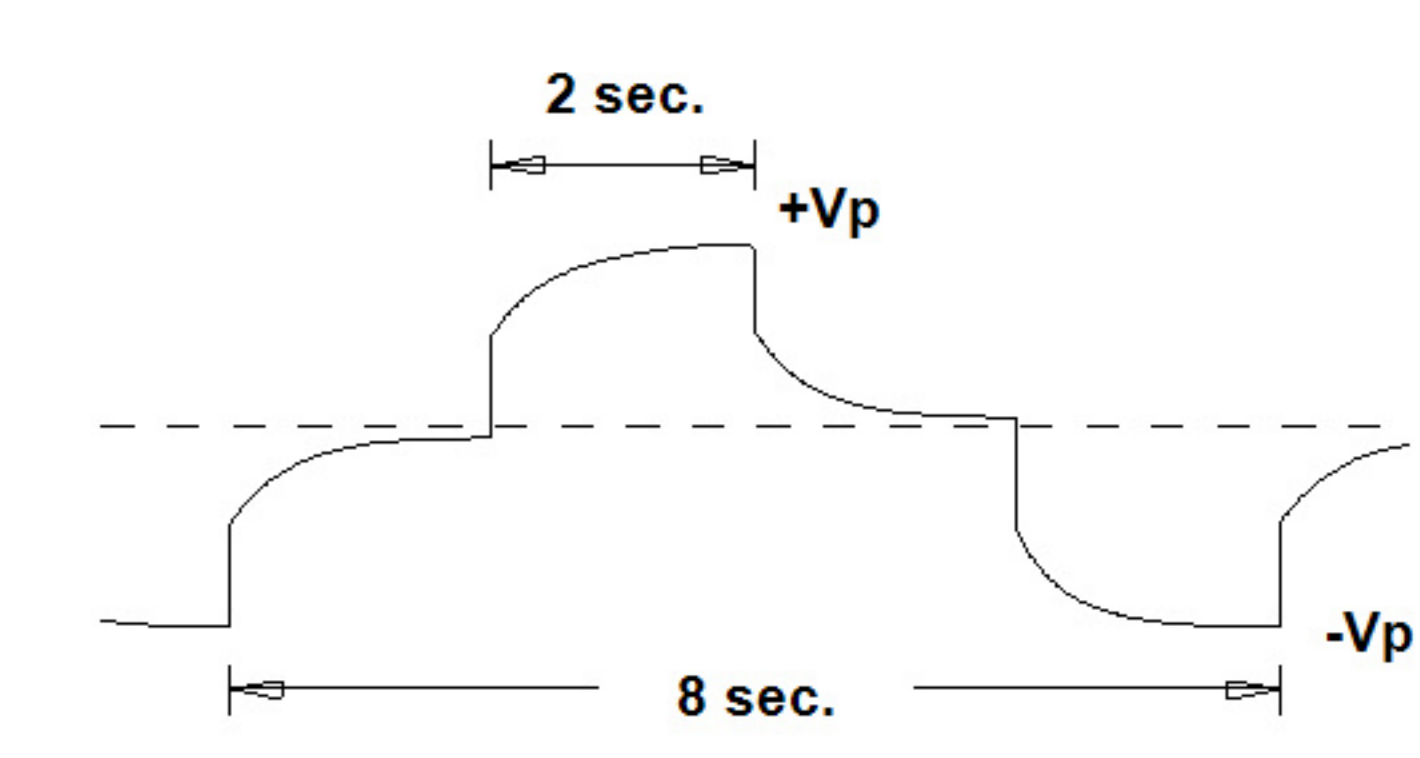

inversion **RES2DINV™**

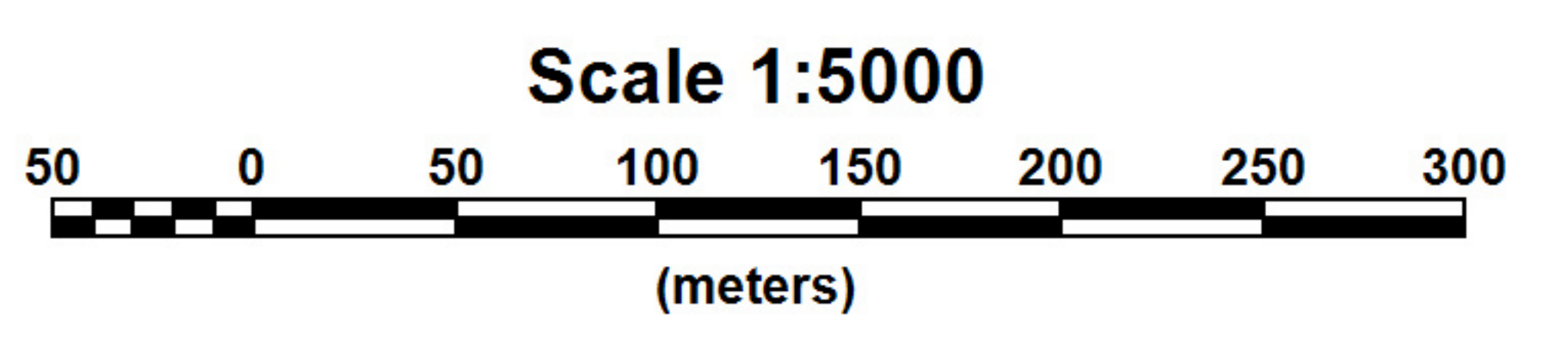

O3 MINING INC.

SISCOE PROJECT
VASSAN TOWNSHIP
VAL D'OR, QUEBEC

Line 2400E

Interpreted by: Joël Simard, P.Geol./Geoph.
 Verified by: Joël Simard, P.Geol./Geoph.
 Surveyed by: J. Melançon
 Date: January 2024
 Ref: 24C672

APPARENT RESISTIVITY PSEUDO SECTION

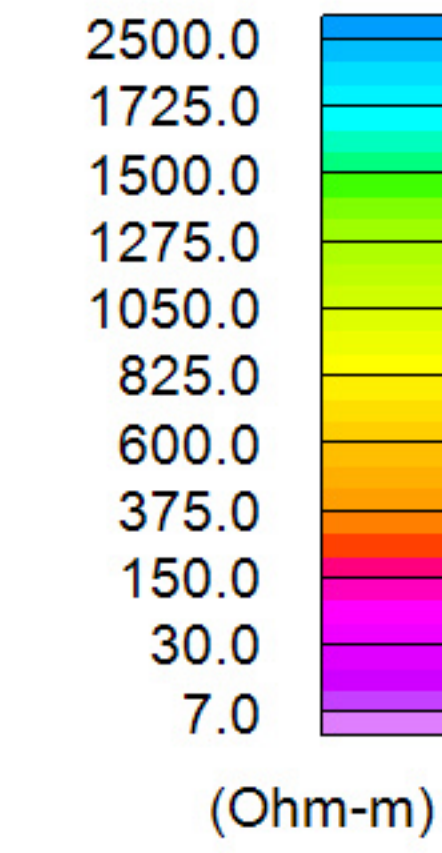
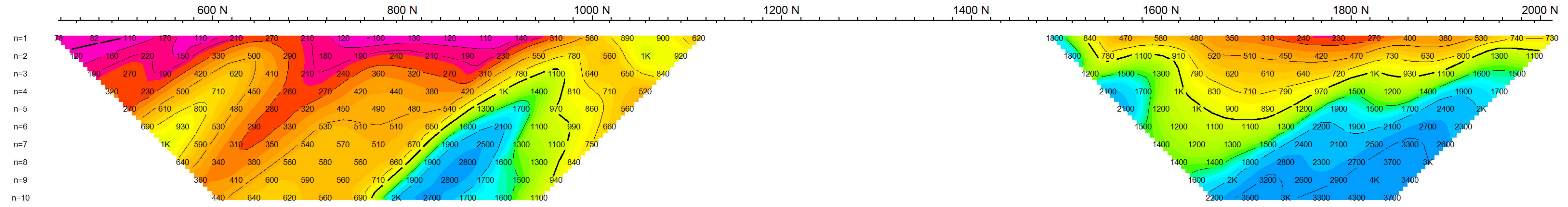

APPARENT CHARGEABILITY PSEUDO SECTION

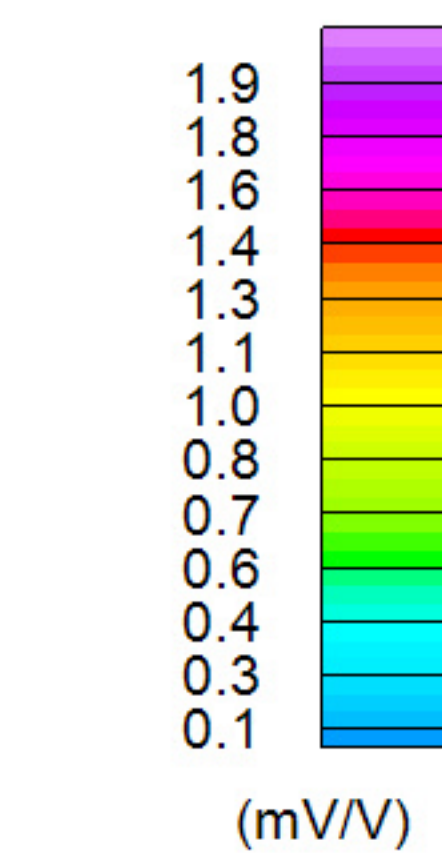
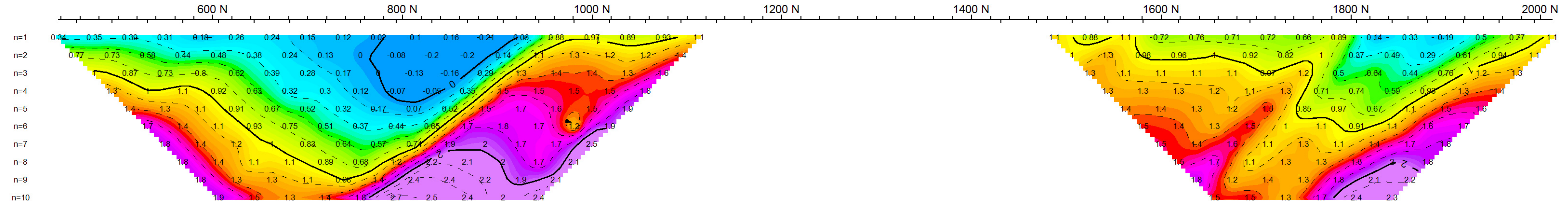

INTERPRETATION

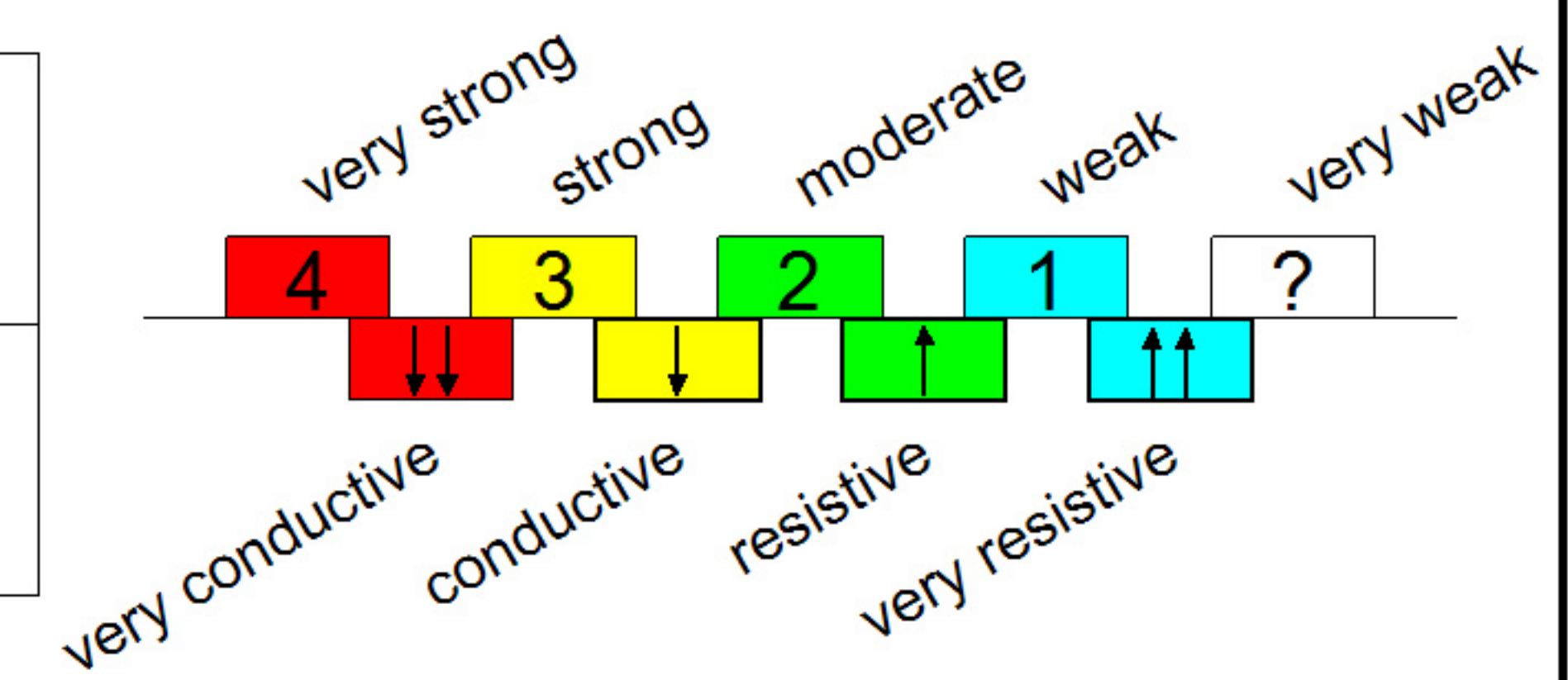

RESISTIVITY TRUE DEPTH SECTION

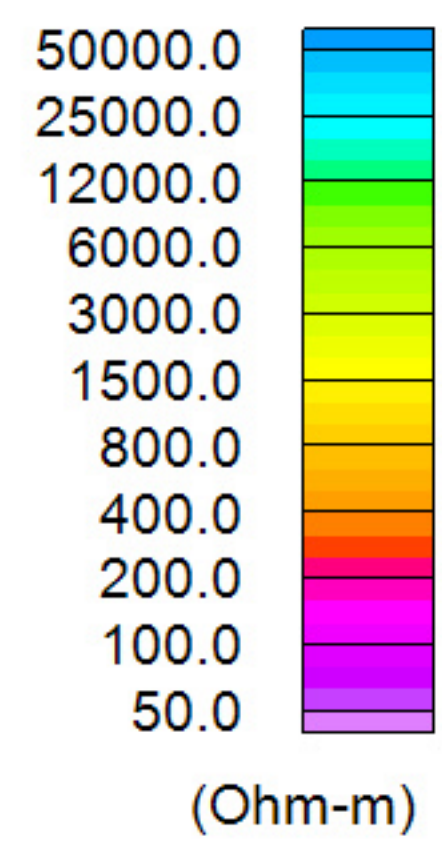
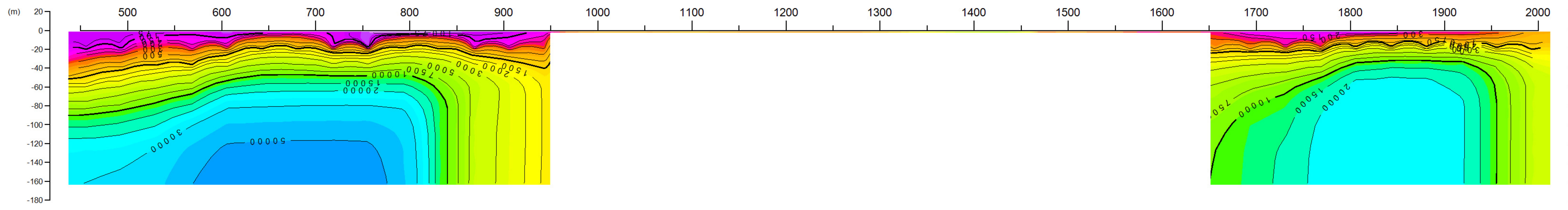

CHARGEABILITY TRUE DEPTH SECTION

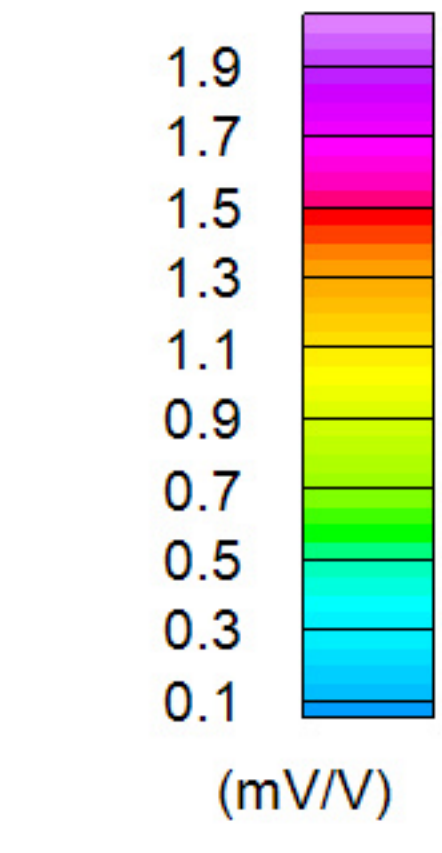
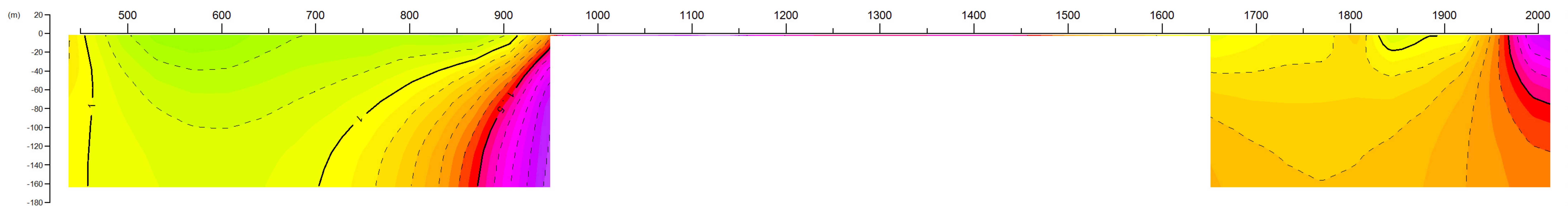

INDUCED POLARIZATION SURVEY

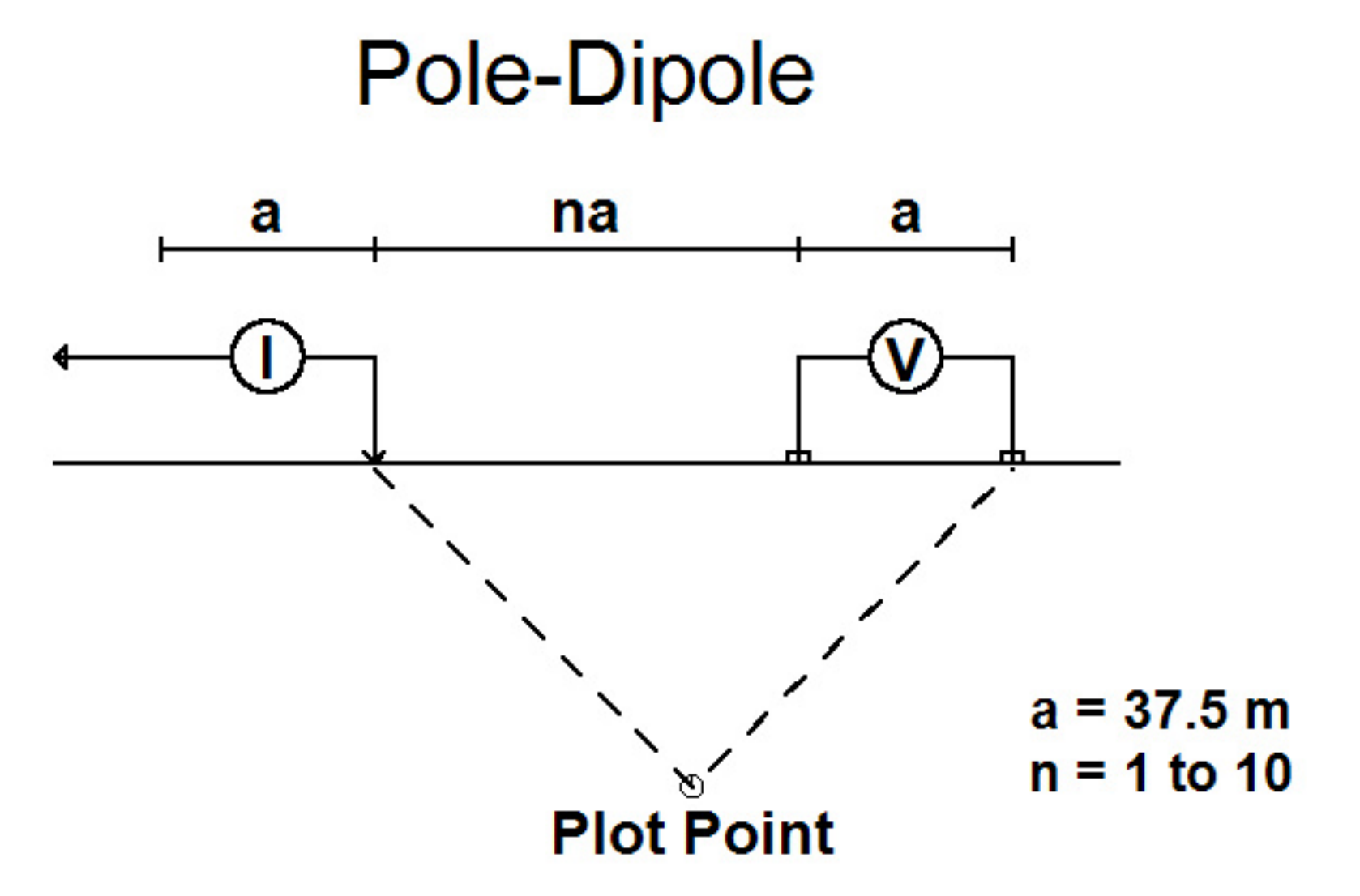

Transmitter: TXII, GDD Instrumentation

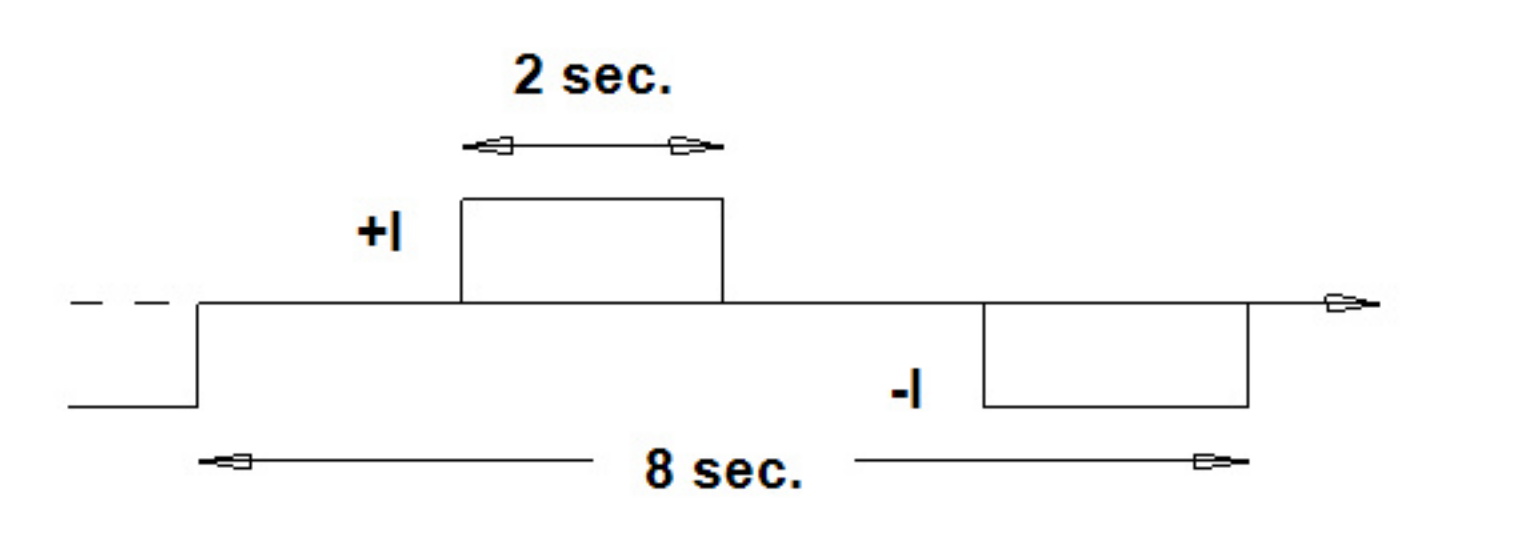

Receiver: Elrec Pro, Iris Instruments

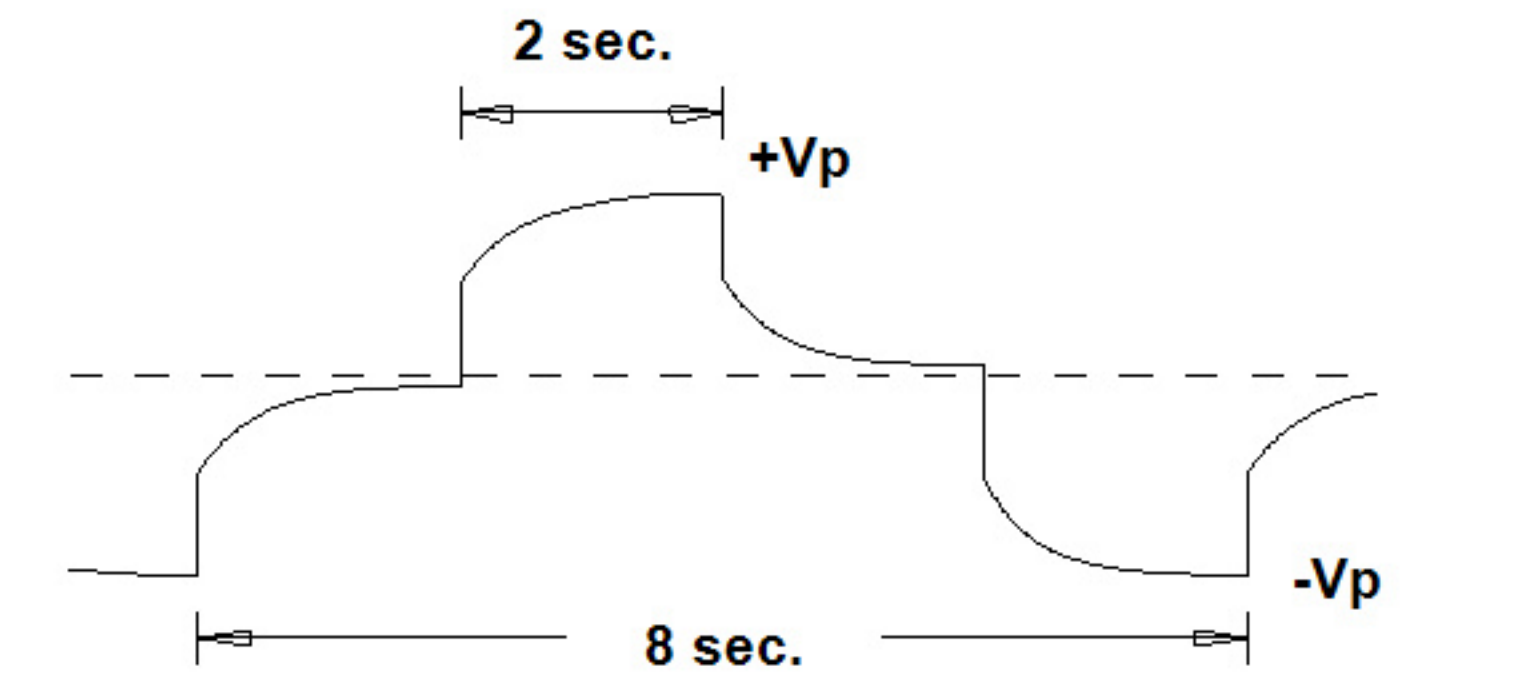

inversion **RES2DINV™**

Scale 1:5000

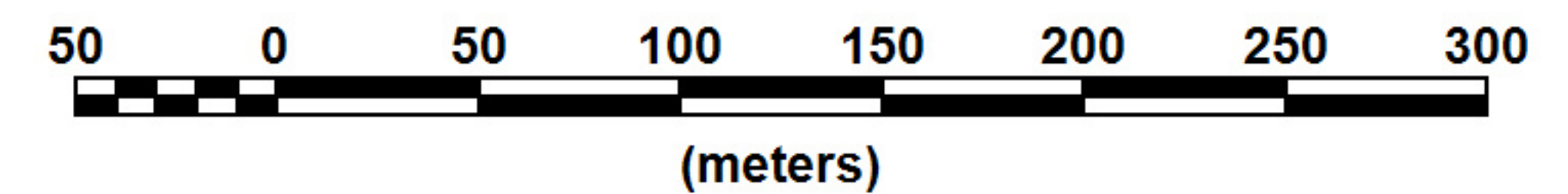

O3 MINING INC.

SISCOE PROJECT
VASSAN TOWNSHIP
VAL D'OR, QUEBEC

Line 2800E

Interpreted by: Joël Simard, P.Geol./Geoph.
 Verified by: Joël Simard, P.Geol./Geoph.
 Surveyed by: J. Melançon
 Date: January 2024
 Ref: 24C672